

Fast

WWW.YOURLASTFLAG.COM



Flag[®]

MADE IN USA



ON LAND & SEA - THE ULTIMATE FLAG

WELCOME TO FAST-FLAG

The ultimate flag for whatever moves you on land and at sea. Fast-Flag is a solid, rigid flag made of aluminum. Our patented design is truly a functioning work of art and a unique way to make a statement.

An entirely new concept with its distinctive sleek aerodynamic design and raked back aft leaning stance, these flags look like they are moving fast in the wind when standing still: thus, the name, Fast-Flag.

No more fabric ripping to shreds. No more limp and droopy flags folding and furling on itself and getting tangled up. Our flags are made of precision cut aluminum components welded to perfection and powder coated to last you a life time. Our flags stand tall and proud 24/7, in any weather condition - becoming an integral part of any boat, yacht or offshore fishing machine.



If you're a boat owner, you know all the issues that comes with the standard fabric flag. Our flags are designed to be installed as a permanent fixture on your vessel prominently displaying her Stars and Stripes.



Fast  **Flag**[®]
WWW.YOURLASTFLAG.COM MADE IN USA

Flag Options, Sizes and Features:

Selecting the right flag for you and your boat.

There are several things to consider when contemplating a Fast-Flag. Size, type and style as well as various features and options. Though there are no absolute rules to follow, when it comes to outfitting your boat with a Fast-Flag, it truly is all about you and your aesthetics. Fortunately, we offer 5 sizes to choose from and 2 distinct types: Stencil or Solid as well as many colors and finish options to help make the selection process easy.



Regarding LED light strips from SplashLights:

Because all Fast-Flags are designed to be permanently mounted on your boat, much like a radar or GPS or any other piece of electronic equipment, you may consider adding LED light strips from SplashLights.com to illuminate your flag. Manufactured specifically for Fast-Flag, SplashLight strips are IP68 and comes with a lifetime warranty and are designed to be installed directly into a slot built into the base of each flag. Available in cool white or RGB (red, green & blue) for the full range of colors. With SplashLight strips, you can highlight your flag to suit any occasion.



Don't be afraid of the dark. From top to bottom, SplashLights has you covered. They offer a full assortment of marine lighting fixtures to fully enhance your boat's appearance at night. Visit splashlights.com for their entire selection.

Please don't allow this to happen to your flag.

The right flag for the right reason.

If you are interested in flying a flag, please consider all the factors.

Sadly, the standard fabric flag just will not last when subjected to high winds and extreme conditions. Especially in the harsh salty marine environment. This is why Fast-Flag was born - to meet the demanding needs of high-performance offshore fishing vessels. If Fast-Flag can survive there, it can survive anywhere, on any vehicle on land and at sea.

This is why we say, Fast-Flag is your last flag - the ultimate flag for whatever moves you.



The ultimate accessory flags: SS-10 & SS-6

The ultimate in accessory flags. Available in 10" and 6" sizes. The compact size and simple design of these flags make them the ideal flag for anything that moves you such as a golf cart, tender or even a forklift. With 4 small screw holes for attachment and super strong 3M double sided adhesive tape, you can mount your flag on any surface you desire.

As with all Fast-Flags, the SS-10 and SS-6 flags are made of solid aluminum and come in 2 styles, the contemporary stencil design as well as the traditional red, white and blue Stars and Stripes. Day or night, these flags become the main design feature which says it all about you, your boat, your golf cart or anything else you ride or drive.

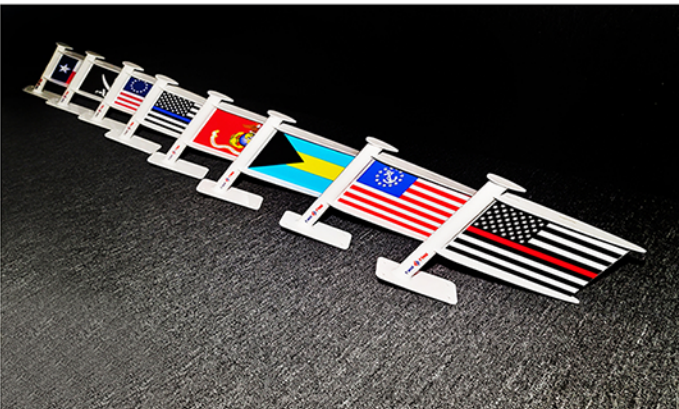
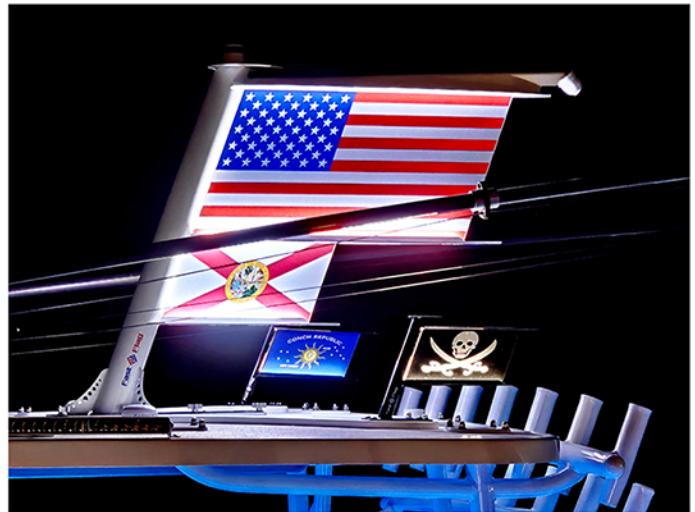
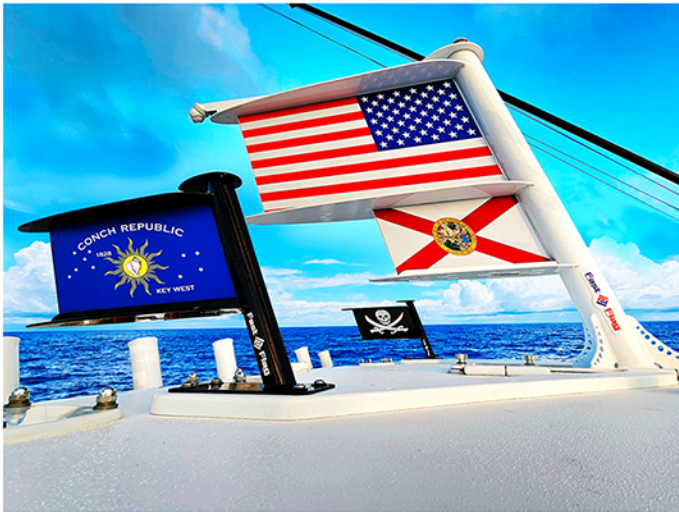

Customization and Speciality flags

Necessity is the mother of invention and at Fast-Flag, this is at the core of what we do and who we are. The majority of our designs and products have been in response to you and your needs.

If you have an idea for a custom flag, a special feature or a unique problem that needs a solution, please reach out to us and let us know. Our design team and graphics experts may be able to help you and find the right solution for your needs.

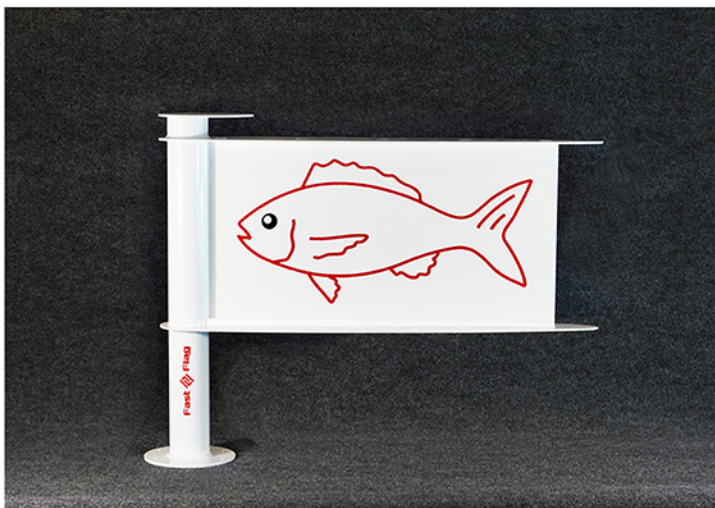
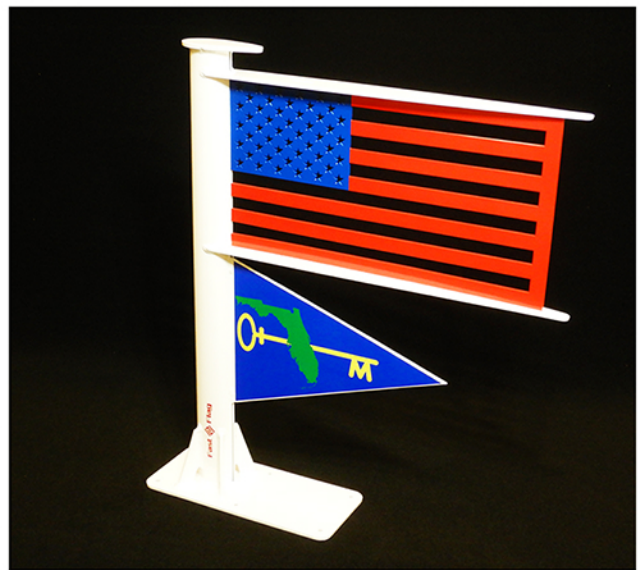

THE SS-SERIES OF FLAGS

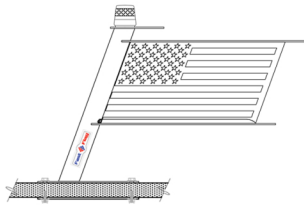

SS-16

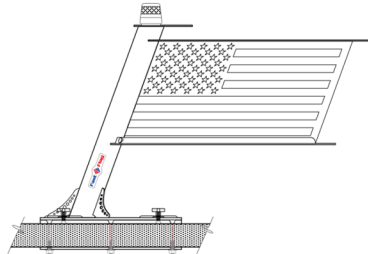

SS-20

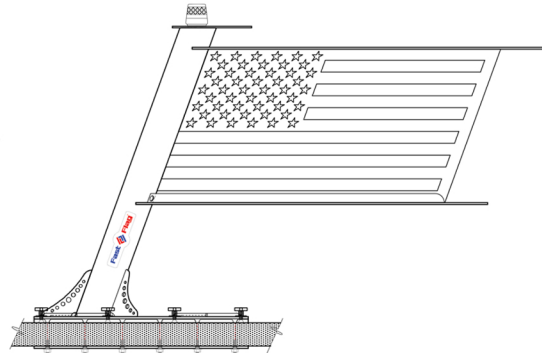

SS-30

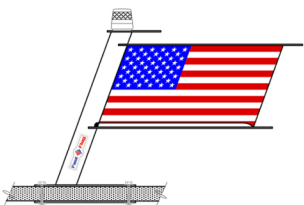

SS-16

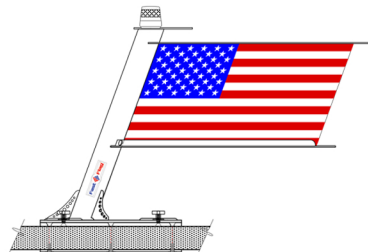

SS-20

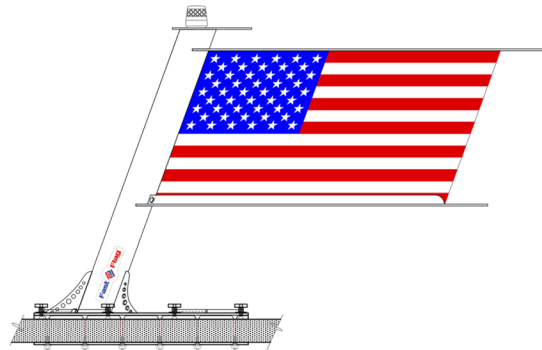

SS-30

SIZING UP YOUR FLAG TO FIT YOUR BOAT

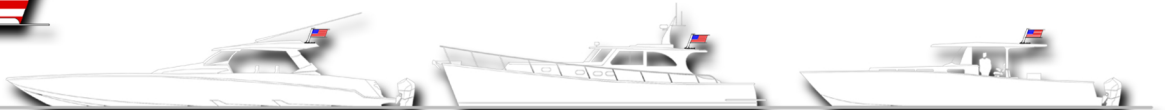
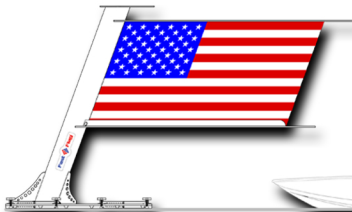

SS-30 SOLID/STENCIL

THE ULTIMATE FLAG FOR LUXURIOUS YACHTS, LARGE CRUISERS AND SPORT FISHING MACHINES TO FROM 35' TO 60' IN LENGTH.

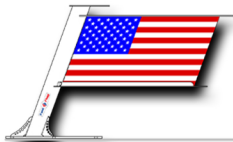

SS-20 SOLID/STENCIL

IDEALLY SUITED FOR MOST CENTER CONSOLES, EUROPEAN CRUISERS, OFFSHORE FISHING BOATS FROM 26' TO 34' IN LENGTH.



SS-16 SOLID/STENCIL

IDEAL FOR RUNABOUTS, CENTER CONSOLES, SPEED BOATS AND SKIFFS RANGING FROM 18' TO 25' IN LENGTH.

COLOR DESIGN OPTIONS FOR SS-30, SS-20 & SS-16

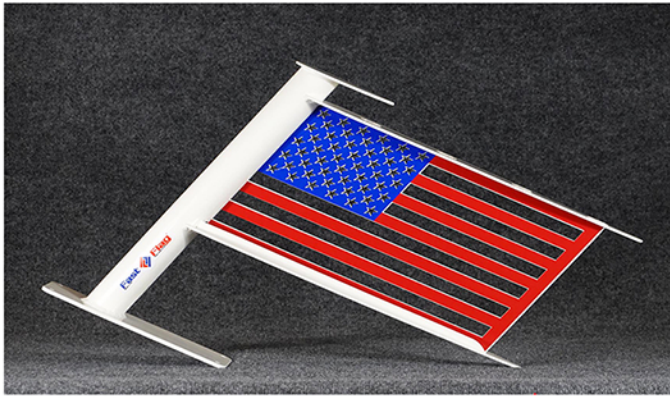

STENCIL RED & BLUE VINYL STENCIL
ON WHITE POWDER COAT

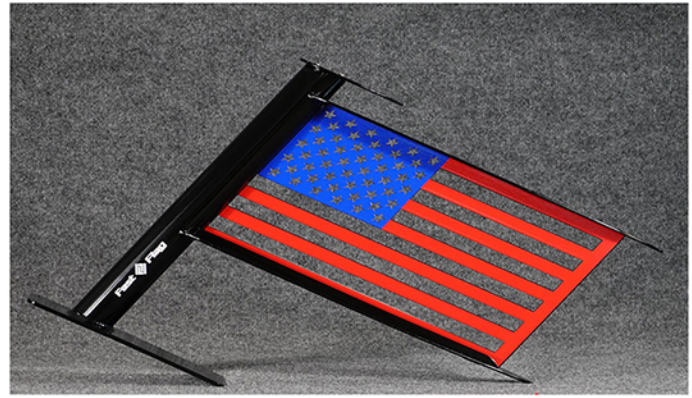

STENCIL RED & BLUE VINYL STENCIL
ON BLACK POWDER COAT

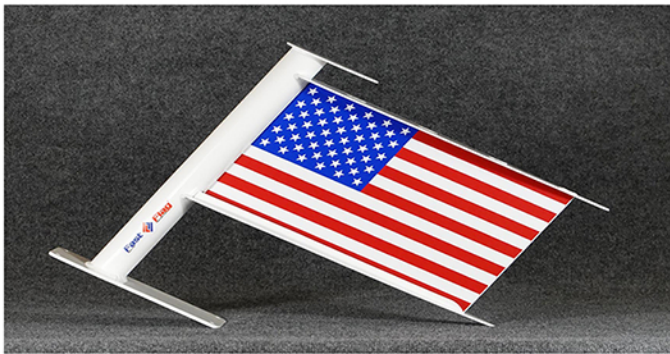

SOLID R/W/B SOLID VINYL
ON WHITE POWDER COAT



SOLID R/W/B SOLID VINYL
ON BLACK POWDER COAT



STENCIL (WHITE) POWDER COAT



STENCIL (BLACK) POWDER COAT

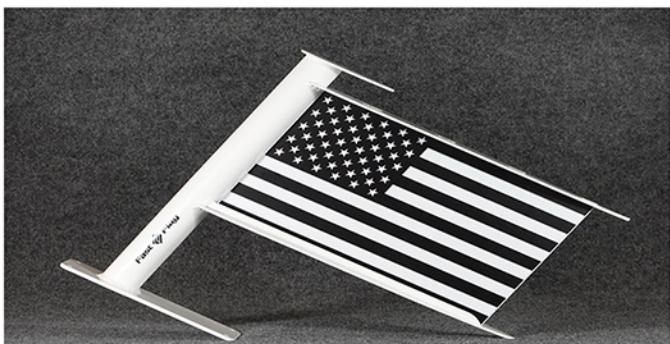

SOLID BLACK & WHITE SOLID VINYL
ON WHITE POWDER COAT



SOLID BLACK & WHITE SOLID VINYL
ON BLACK POWDER COAT

Solid vinyl flag designs

Regardless of what you are looking for, whether it is a single flag design or double flag design, customization is the key. It is easy to do with our solid vinyl flag options, we can offer you endless possibilities to make it fit your lifestyle. Including your ensign flag and of course the flags of our 50 states. Fly the Stars and Stripes proudly with your own unique style.

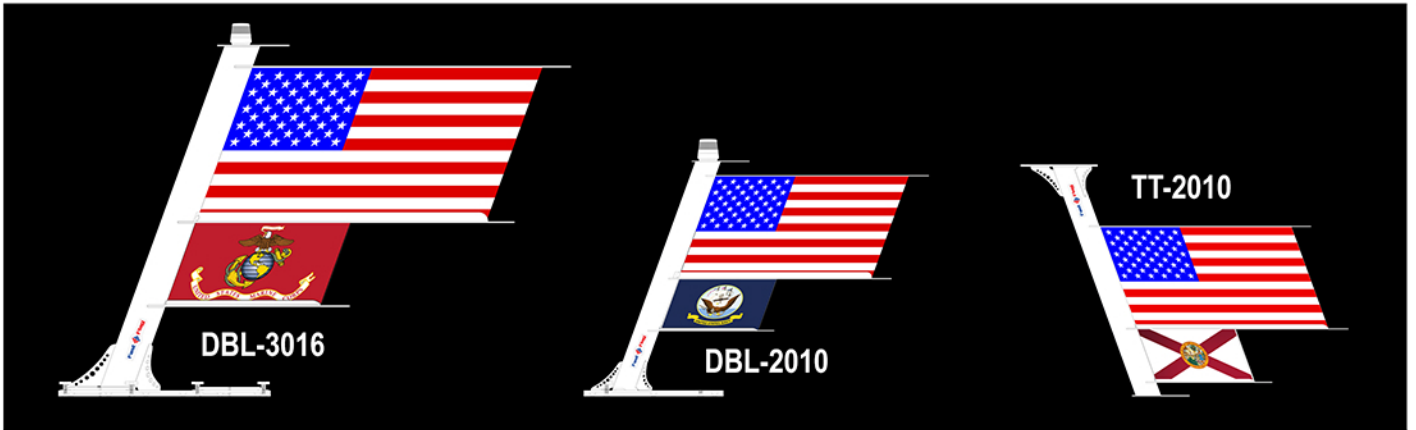

Solid vinyl flag designs

All solid SS-30, SS-20 and SS-16 flags as well as all double flags DBL-3010, DBL-2010 and TT-2010 may be ordered with the custom vinyl graphics. Made of extremely durable full color UV resistant vinyl wrap material same as the hull boat wraps you see on the water today, now your flag may be customized in any configuration with any of these designs shown below. Pair these designs with either a solid white powder coated mast and super structure or gloss black to create the perfect design for your boat.



Red & Blue line

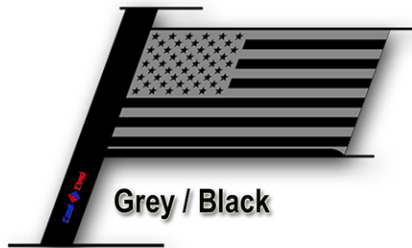

Grey / Black



Yacht Flag

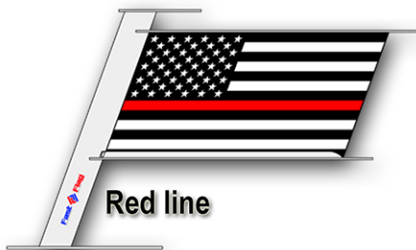

Red line

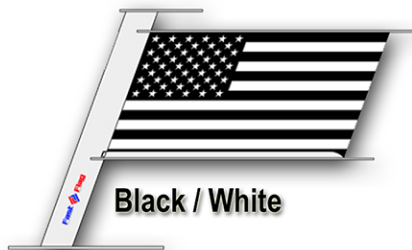

Black / White

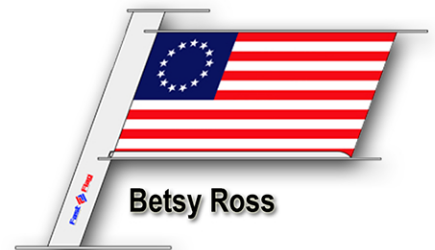

Betsy Ross



Blue line

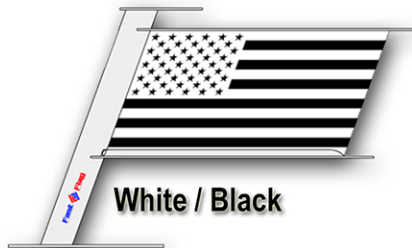

White / Black

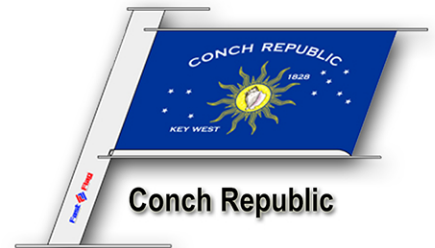

Conch Republic



Army Green line



Blue, Red & Green



Jolly Roger

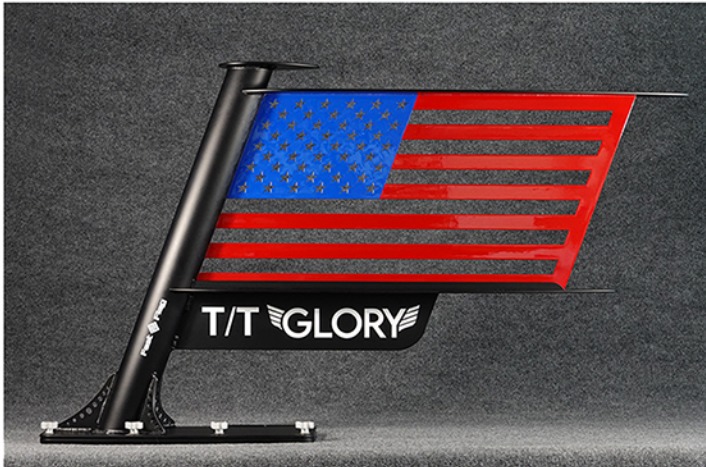
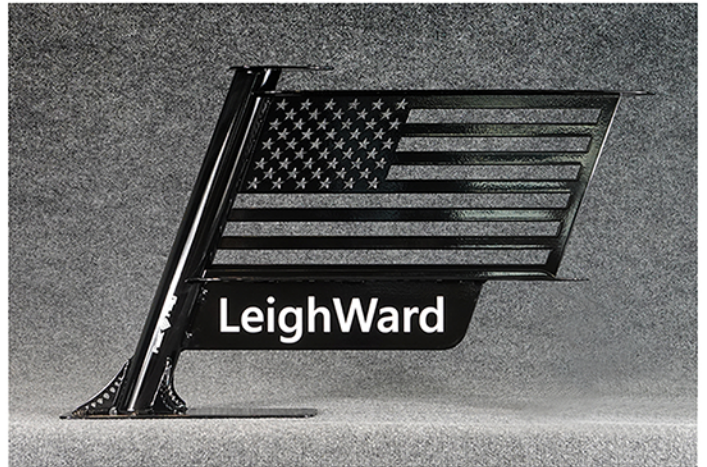

SOLID WELDED NAME PLATE: AVAILABLE FOR ALL SS-30, SS-20 AND SS-16 FLAGS

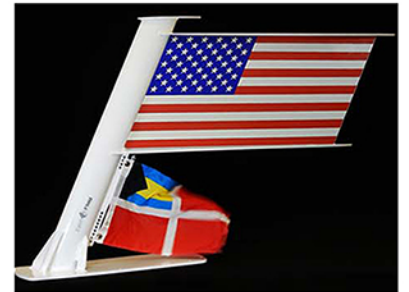
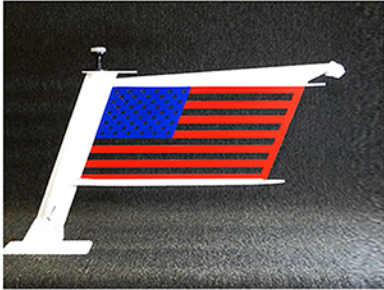
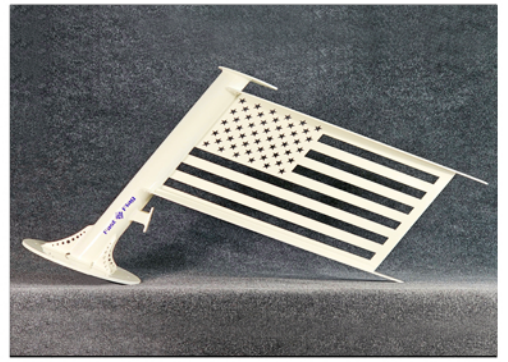

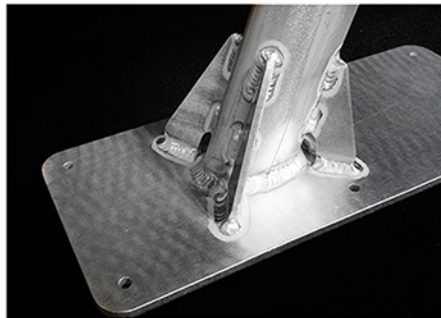
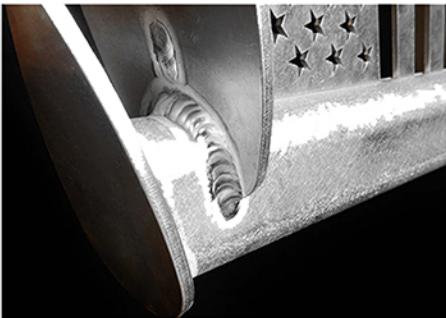
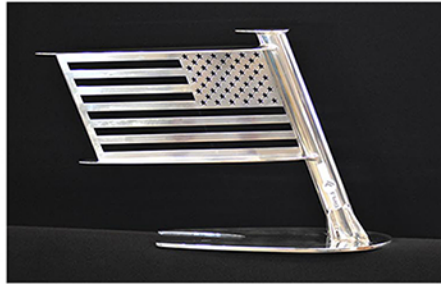
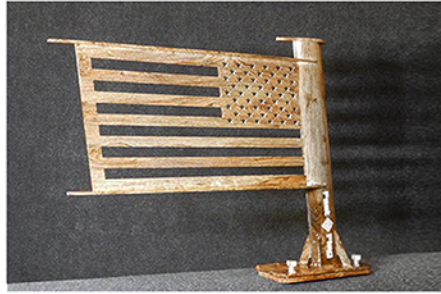
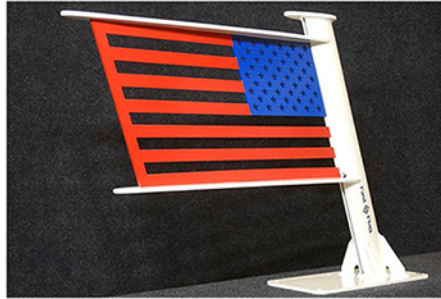
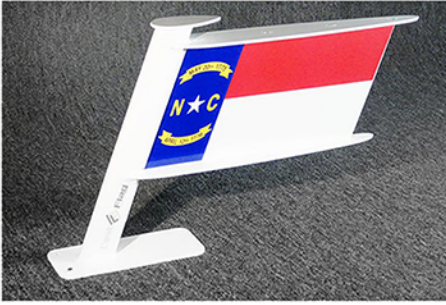



THE DOUBLE FLAG SERIES

DBL-3016FDB & DBL-2010FDB

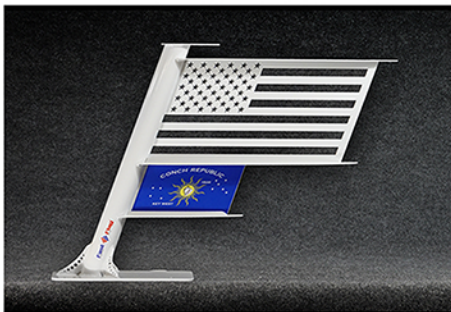

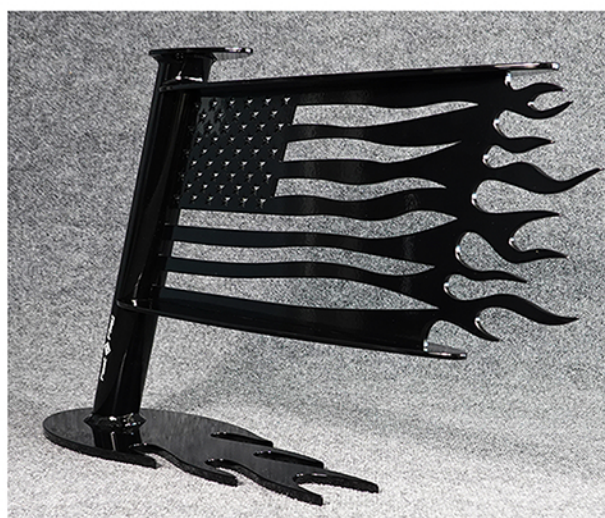
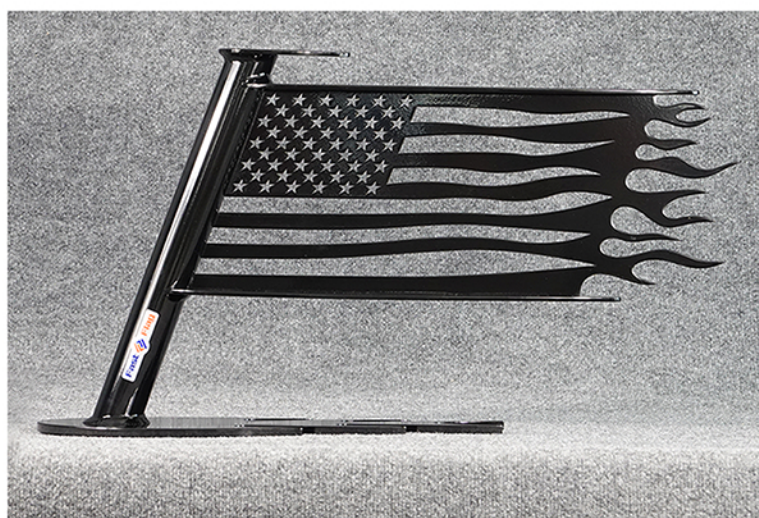

THE EXTREME FLAG: SS-16EX, SS-20EX AND SS-30EX



THE INTERNATIONAL SERIES



AVAILABLE ONLY WITH SS-16, SS-20 AND SS-30 SIZES

THE TUNA TOWER SERIES

THE ULTIMATE FLAGS FOR THE ULTIMATE FISHING MACHINES



TT-2010

**THE UNDER MOUNTED DOUBLE
FLAG: TT-2010 IS A SOLID 20"
AMERICAN FLAG ABOVE A
SOLID 10" STATE FLAG**



TT-16 SOLID

**THE TT-16 IS A 16" UNDER MOUNTED
AMERICAN FLAG. AVAILABLE
IN SOLID RED/WHITE & BLUE
AND IN STENCIL.**

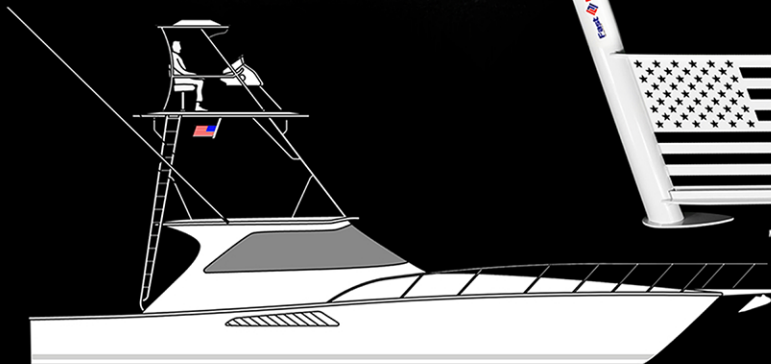

TT-16 STENCIL

SS-30FDB

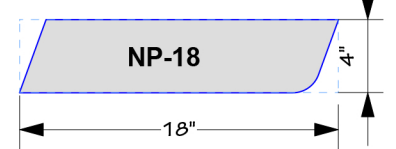
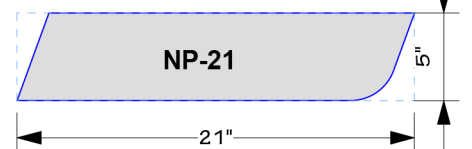
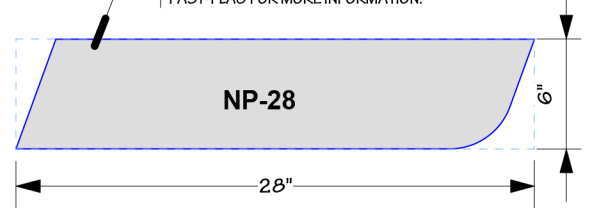
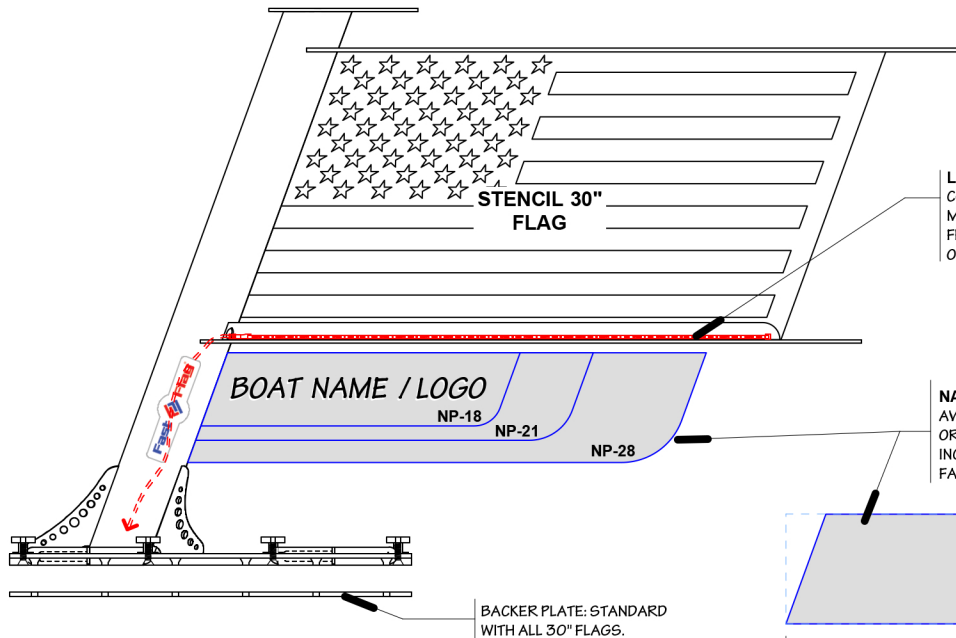

SS-30FDB AVAILABLE FEATURES AND OPTIONS

THE SS-30FDB 'STENCIL' AND THE SS-30FDB 'SOLID' HAVE SEVERAL OPTIONAL FEATURES WHICH MAY BE INCLUDED IN YOUR BUILD SUCH AS CUSTOM NAME PLATES AND LED LIGHT STRIPS TO ILLUMINATE YOUR FLAG AT NIGHT. FOR NAVIGATION LIGHTS AND CAMERAS, REFER TO PAGE 2.

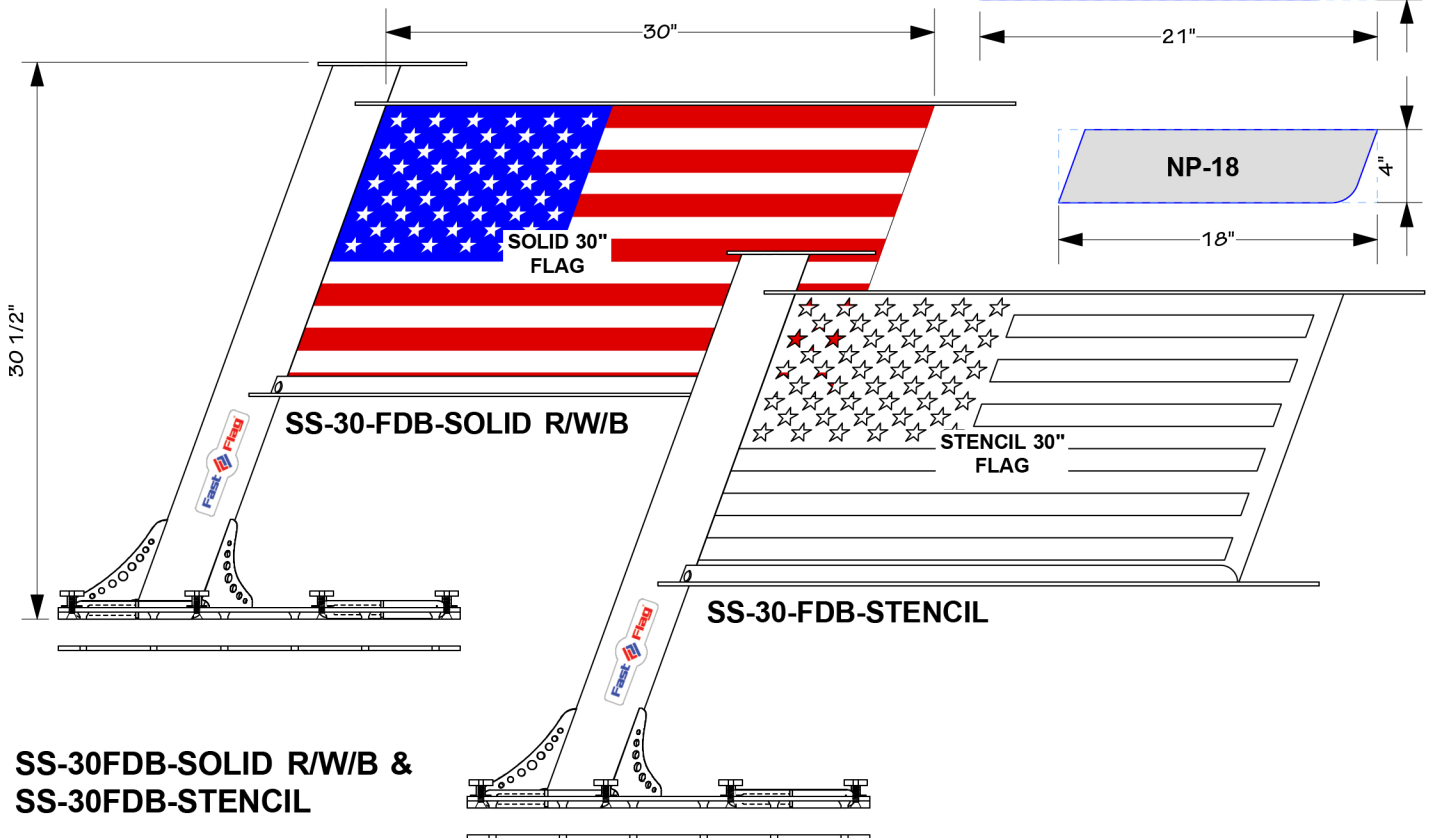

SS-30FDB-SOLID R/W/B & SS-30FDB-STENCIL

THE SS-30FDB IS AVAILABLE IN 2 STYLES, THE CONTEMPORARY STENCIL DESIGN WITH THE STARS AND STRIPES CUT OUT OF ONE SHEET OF ALUMINUM AND THE MORE TRADITIONAL LOOKING FLAG WITH ITS SOLID STARS AND STRIPES IN RED/WHITE & BLUE VINYL WRAP APPLIQUE OVER SOLID ALUMINUM POWDER COATED PLATE. THE SS-30 IS IDEAL FOR MOST LARGER BOATS IN THE RANGE OF 35' TO 60'.

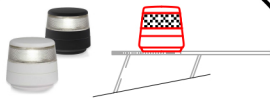

HELLA MARINE ANCHOR LIGHT

ANCHOR LIGHT: HELLA 360 2NM COMPACT ANCHOR LAMP LED. THIS OPTION IS AVAILABLE FOR ALL SS-30, SS-20 AND SS-16 FLAGS WHEN SPECIFIED WITH YOUR ORDER.

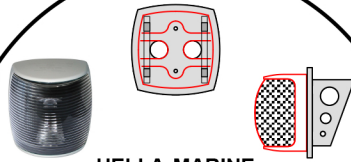

HELLA MARINE MAST LIGHT

HELLA - 3NM MAST HEAD LAMP: 2LT 959 940-211. THIS OPTION IS ONLY AVAILABLE FOR SS-30 SIZE FLAGS WHEN SPECIFIED WITH YOUR ORDER.

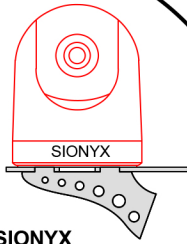

SIONYX CAMERA

SIONYX MOUNT: CUSTOM ALUMINUM MOUNTING PLATE FOR SIONYX CAMERA. THIS OPTION IS ONLY AVAILABLE FOR SS-30 SIZE FLAGS WHEN SPECIFIED WITH YOUR ORDER.

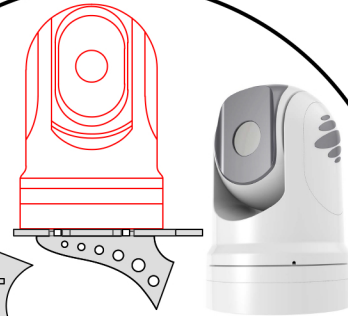

OMNISENSE SYSTEMS ULYSSES MICRO CAMERA

ULYSSES MICRO MOUNT: CUSTOM ALUMINUM MOUNTING PLATE FOR ULYSSES MICRO CAMERA. THIS OPTION IS ONLY AVAILABLE FOR SS-30 SIZE FLAGS WHEN SPECIFIED WITH YOUR ORDER.

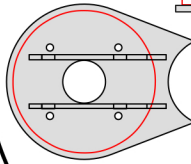
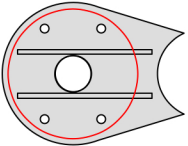

GOST MINI BALL WIDE ANGLE CAMERA

FLAG-CAM: INTEGRAL FLAG-CAM FEATURE FOR GOST MINI BALL SECURITY CAMERA. THIS OPTION IS ONLY AVAILABLE FOR SS-30 AND SS-20 SIZE FLAGS WHEN SPECIFIED WITH YOUR ORDER.

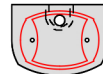
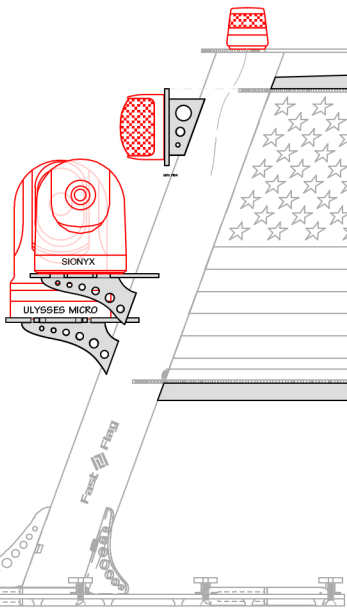

HELLA MARINE STERN LIGHT

HELLA MARINE LED NAVIGATION 2NM STERN LAMP # 2LT 980 520-511. THIS OPTION IS ONLY AVAILABLE FOR SS-30 SIZE FLAGS WHEN SPECIFIED WITH YOUR ORDER.

NAVIGATION LIGHTS AND CAMERAS FOR SS-30FDB, SSB-30FDB & DBL-3016FDB

- HELLA MARINE ANCHOR LIGHT
- HELLA MARINE MAST LIGHT
- HELLA MARINE STERN LIGHT
- GOST MINI BALL WIDE ANGLE CAMERA
- SIONYX CAMERA
- OMNISENSE SYSTEMS/ULYSSES MICRO CAMERA

SSB-30FDB

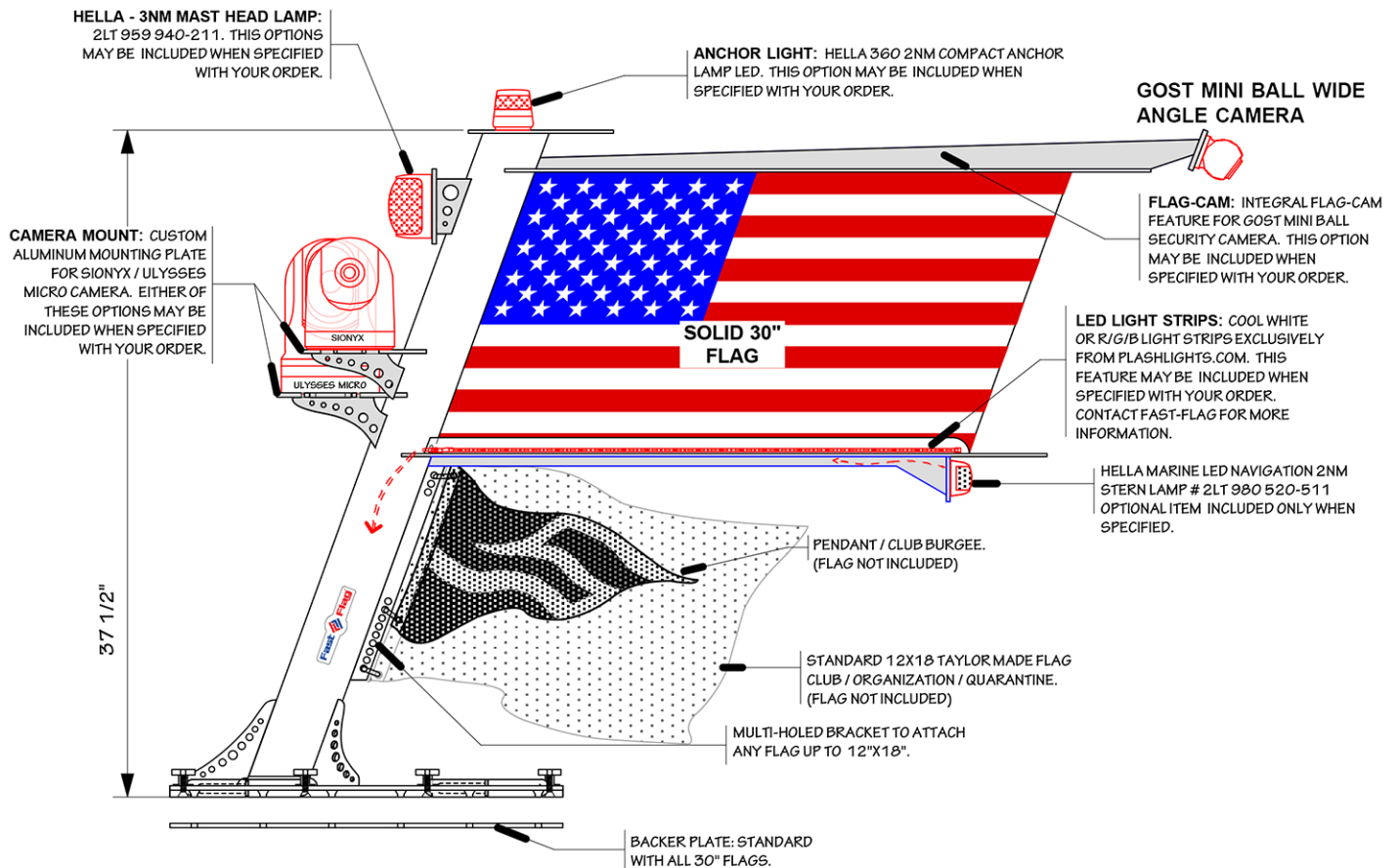

SSB-30FDB SOLID (PORT SIDE VIEW)

SSB-30FDB AVAILABLE FEATURES AND OPTIONS

THE SSB-30-FDB IS A SOLID RED/WHITE & BLUE FLAG WITH INTEGRAL FOLD DOWN BASE AND A MULTI-HOLED BRACKET WELDED TO THE MAST FOR THE ATTACHMENT OF A STANDARD FABRIC FLAG OR YACHT BURGEE. SOME OF THE AVAILABLE FEATURES AND OPTIONS FOR THIS FLAG INCLUDE THE OPTIONAL MAST LIGHT/ANCHOR LIGHT, FLAG-CAM MOUNT FOR GOST SURVEILLANCE SYSTEMS, SIONYX CAMERA MOUNT OR OMNISENSE SYSTEMS ULYSSES MICRO CAMERA AS WELL AS LED LIGHT STRIPS FROM PLASHLIGHTS.COM. CONTACT FAST-FLAG FOR FURTHER INFORMATION.

SS-20

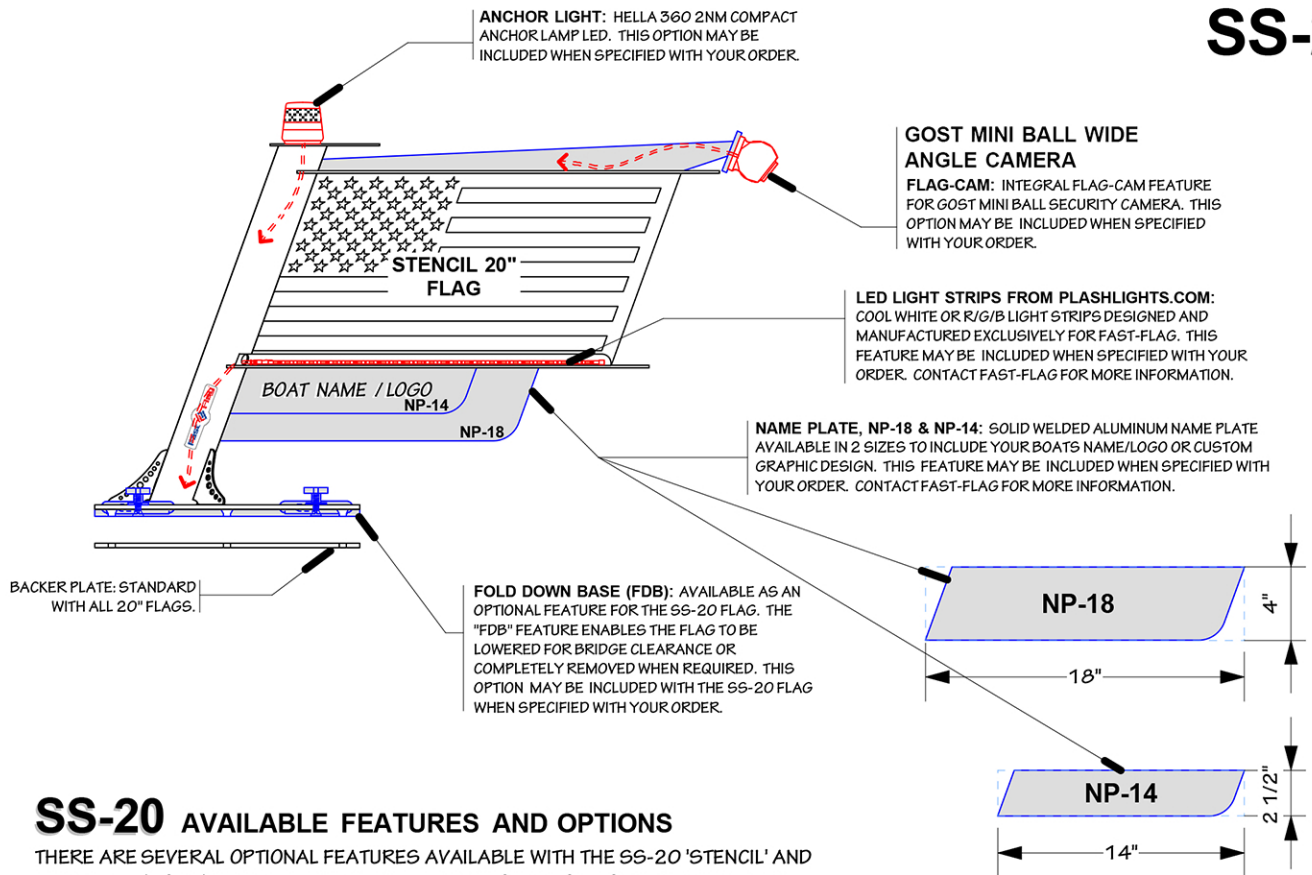

SS-20 AVAILABLE FEATURES AND OPTIONS

THERE ARE SEVERAL OPTIONAL FEATURES AVAILABLE WITH THE SS-20 'STENCIL' AND THE SS-20 'SOLID' FLAGS: INTEGRAL FLAG-CAM MOUNT FOR GOST SURVEILLANCE SYSTEMS, AS WELL AS 2 VARYING SIZES OF CUSTOM NAME PLATES. ADDITIONALLY, A MAST LIGHT/ANCHOR LIGHT AS WELL AS LED LIGHT STRIPS MAY BE ADDED TO ILLUMINATE YOUR FLAG AT NIGHT.

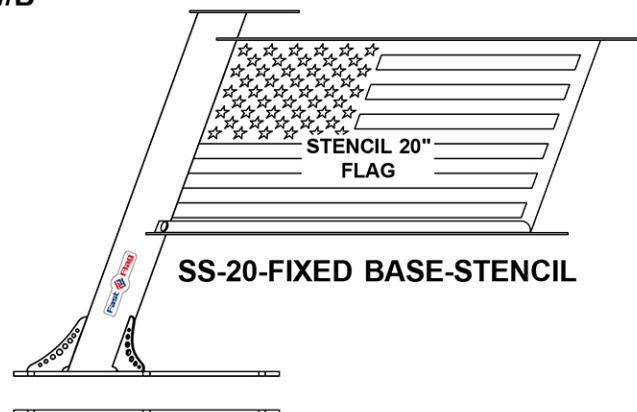
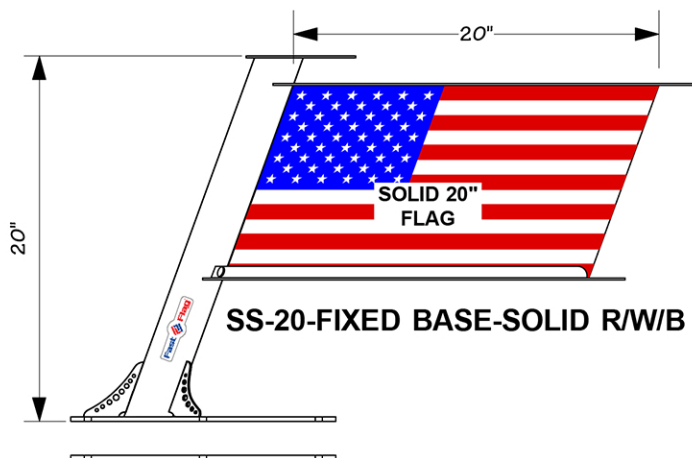

SS-20 SOLID R/W/B and SS-20 STENCIL

THE SS-20 FLAG IS AVAILABLE IN 2 STYLES, THE CONTEMPORARY STENCIL DESIGN WITH THE STARS AND STRIPES CUT OUT OF ONE SHEET OF ALUMINUM AND SS-20 SOLID, THE MORE TRADITIONAL LOOKING FLAG WITH ITS SOLID STARS AND STRIPES IN RED/WHITE AND BLUE VINYL WRAP APPLIQUE OVER SOLID ALUMINUM POWDER COATED PLATE. THE SS-20 IS IDEAL FOR MOST BOATS RANGING FROM 26' TO 34' IN LENGTH.



FOLD DOWN BASE FEATURE

AVAILABLE WITH SS-20, SS-30, SSB-30, DBL-2010 AND DBL-3016

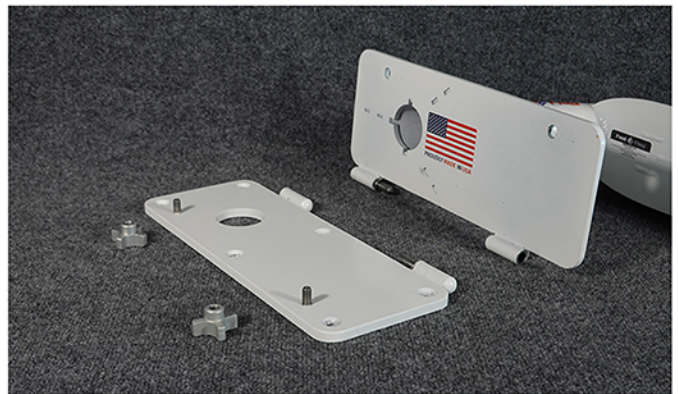
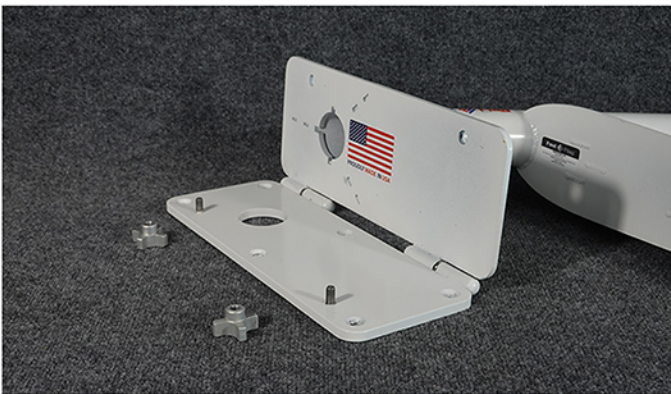
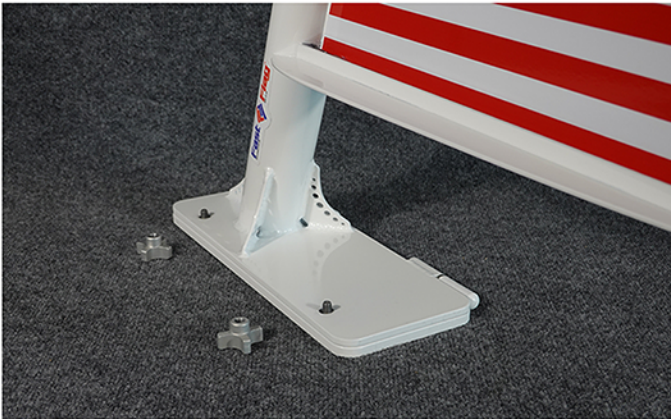

DBL-3016FDB

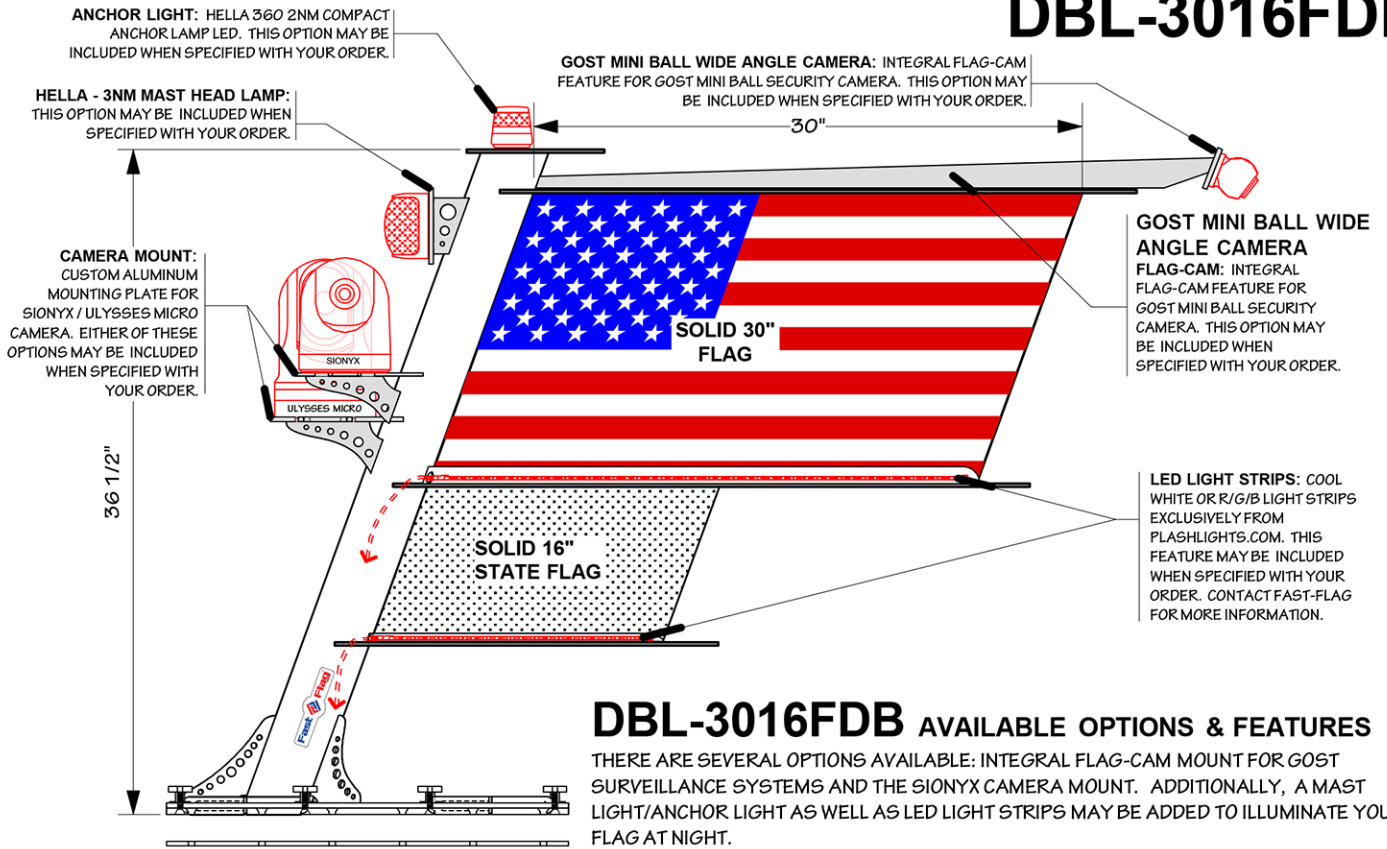

DBL-3016FDB-SOLID R/W/B

DBL-2010FDB

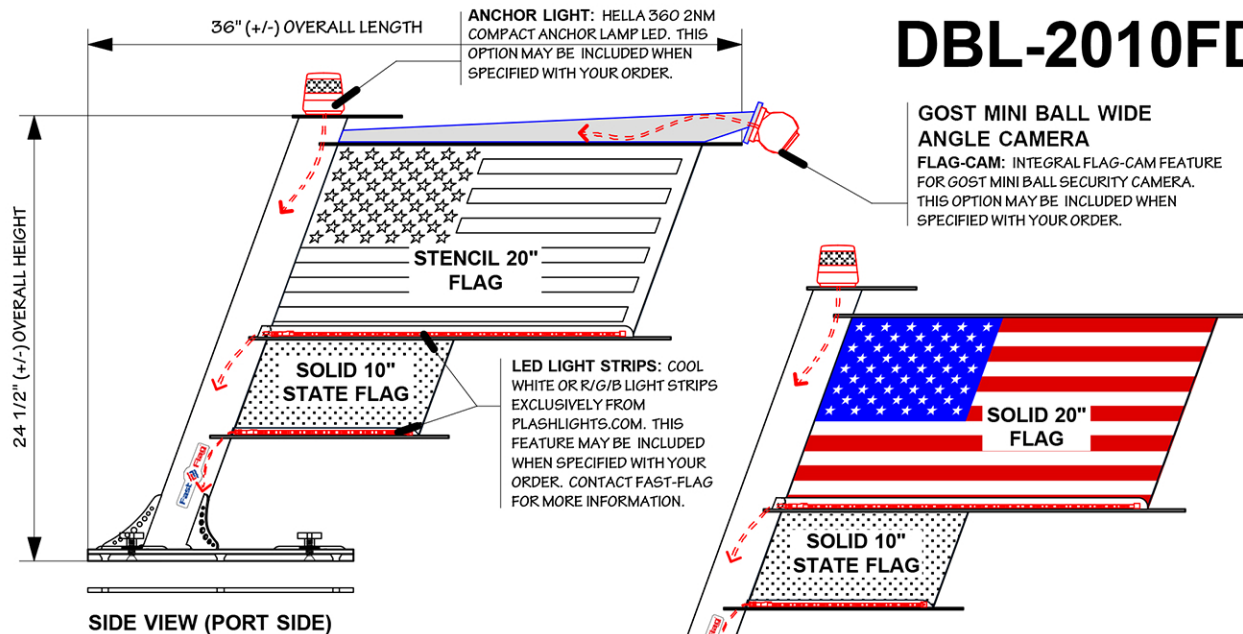

DBL-2010FDB

THE DBL-2010 HAS A SOLID 10" FLAG AS THE LOWER, STATE FLAG WITH THE 20" AMERICAN FLAG IN SOLID OR STENCIL ABOVE. THE AVAILABLE OPTIONS FOR THIS FLAG INCLUDES THE FLAG-CAM FEATURE WITH THE GOST SURVEILLANCE SYSTEM AS WELL AS TO A MAST LIGHT/ANCHOR LIGHT AND LED LIGHT STRIPS TO ILLUMINATE YOUR FLAG AT NIGHT.

TT-2010

TT-2010

AVAILABLE OPTIONS & FEATURES

THE ULTIMATE FLAG FOR THE ULTIMATE FISHING MACHINES. THE TT-2010 COMBINES THE TRADITIONAL LOOKING R/W/B 20" AMERICAN FLAG WITH ANY 10" STATE FLAG OF YOUR CHOICE IN ONE EYE CATCHY PACKAGE. DESIGNED TO BE UNDER MOUNTED, THIS FLAG WILL DEFINE YOU, YOUR BOAT AND PRESENCE ON THE WATER. TO ADD AN ADDITIONAL LEVEL OF SPARKLE AT NIGHT, THESE FLAGS CAN ALSO BE ILLUMINATED WITH PLAGHLIGHTS COOL WHITE LED STRIP LIGHTS. THIS FEATURE MAY BE INCLUDED WHEN SPECIFIED WITH YOUR ORDER. CONTACT FAST-FLAG FOR MORE INFORMATION.

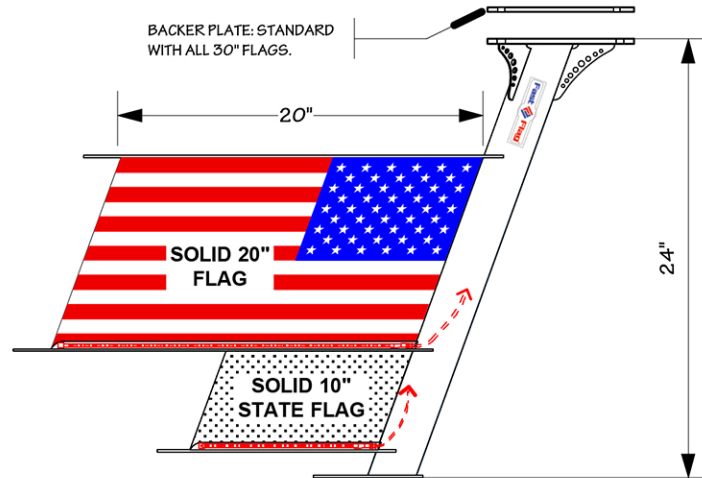

STARBOARD SIDE VIEW

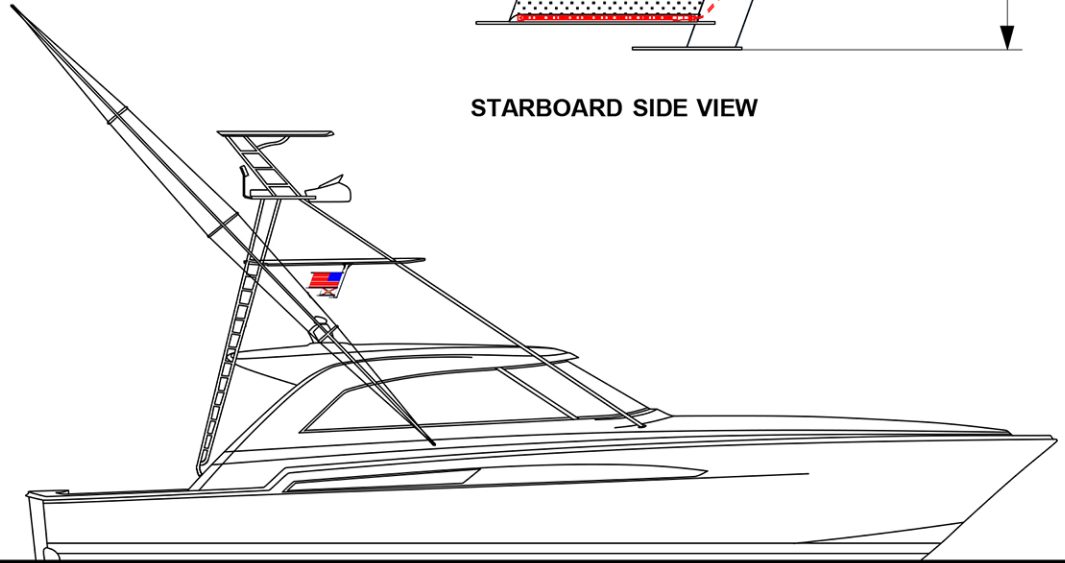

TT-16 AVAILABLE OPTIONS & FEATURES

AVAILABLE IN STENCIL AND OR SOLID, THE TT-16 IS A 16" SIZE FLAG DESIGNED AND BUILT TO BE UNDER MOUNTED AND CAN BE ILLUMINATED WITH LED LIGHT STRIPS FROM PLASHLIGHTS.COM.

LED LIGHT STRIPS FROM PLASHLIGHTS.COM: COOL WHITE OR R/G/B LIGHT STRIPS DESIGNED AND MANUFACTURED EXCLUSIVELY FOR FAST-FLAG. THIS FEATURE MAY BE INCLUDED WHEN SPECIFIED WITH YOUR ORDER. CONTACT FAST-FLAG FOR MORE INFORMATION.

TT-16

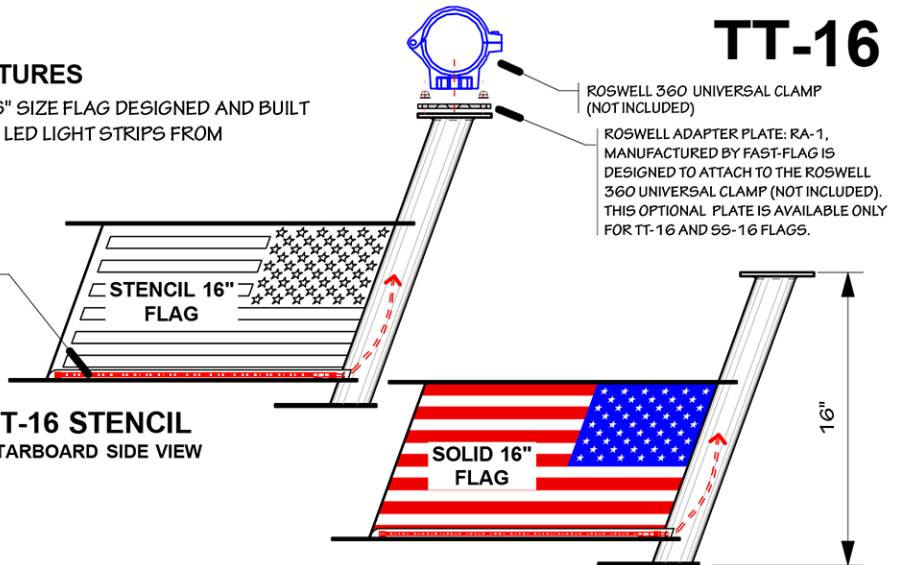

TT-16 STENCIL
STARBOARD SIDE VIEW

TT-16 SOLID
STARBOARD SIDE VIEW

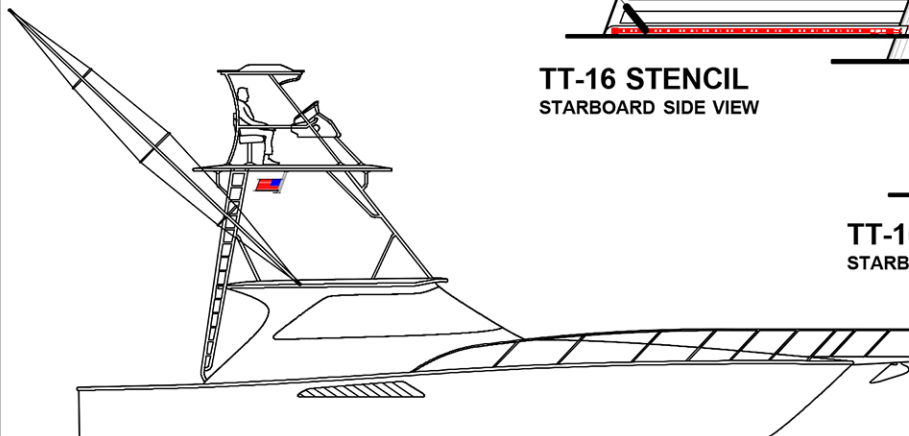

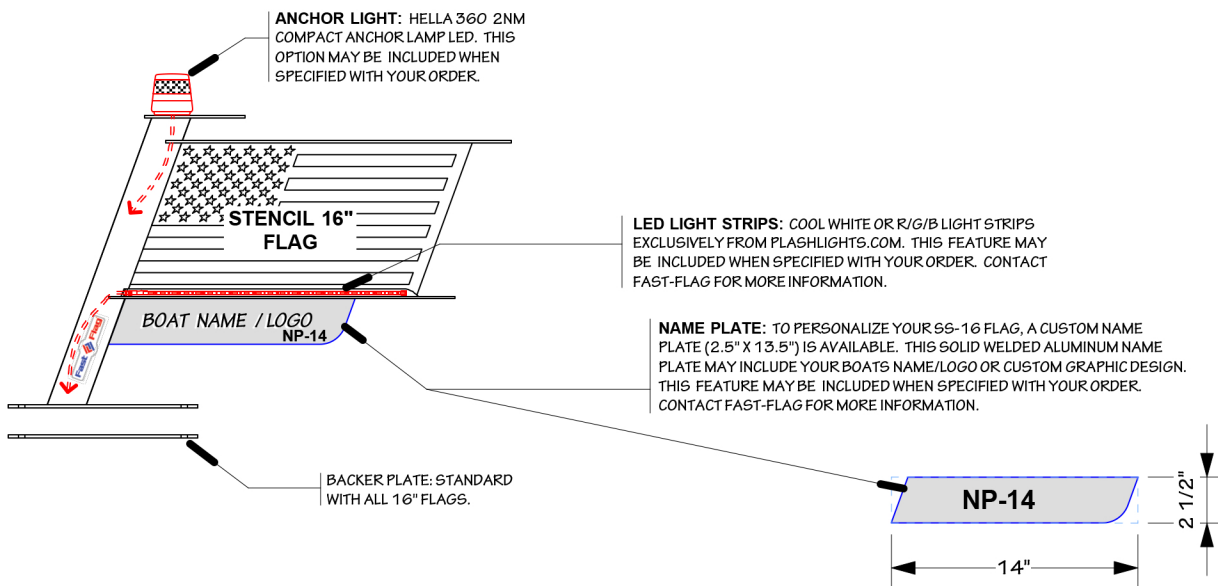

SS-16 FEATURES / OPTIONS

THE SS-16 SOLID AND STENCIL FLAGS ARE AVAILABLE WITH **FIXED-BASE ONLY**. THE COMPACT SIZE OF THIS FLAG MAKES IT IDEAL FOR MOST BOATS RANGING FROM 18 TO 25 IN LENGTH. PERFECT FOR SMALLER RUNABOUTS AND SKIFFS. A MAST LIGHT/ANCHOR LIGHT AS WELL AS LED LIGHT STRIPS MAY BE ADDED TO ILLUMINATE YOUR FLAG AT NIGHT.

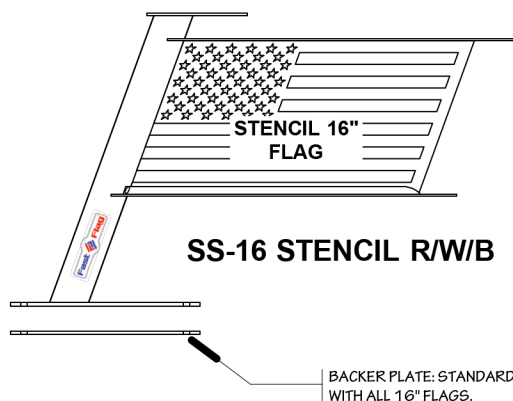
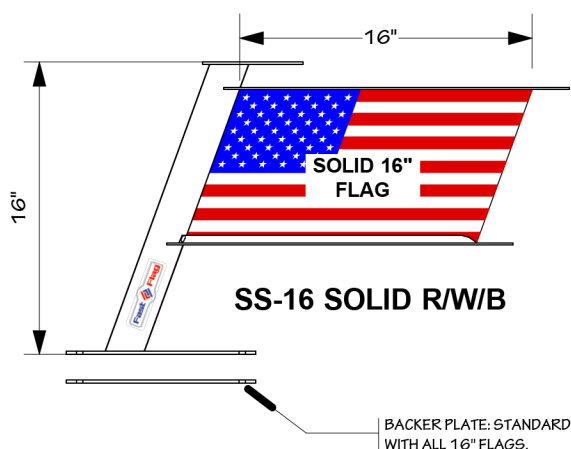

SS-16EX

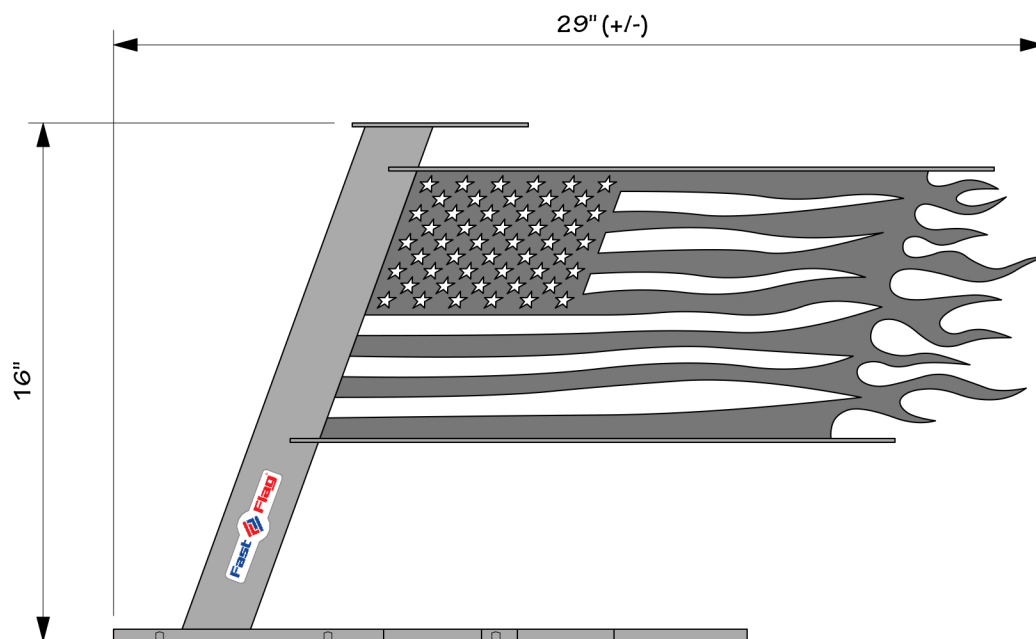

PORT (LEFT) SIDE

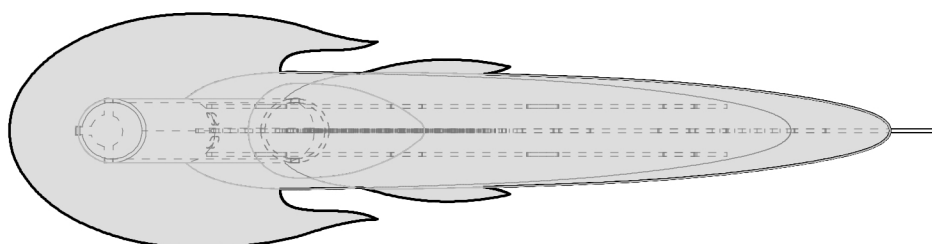

PLAN VIEW

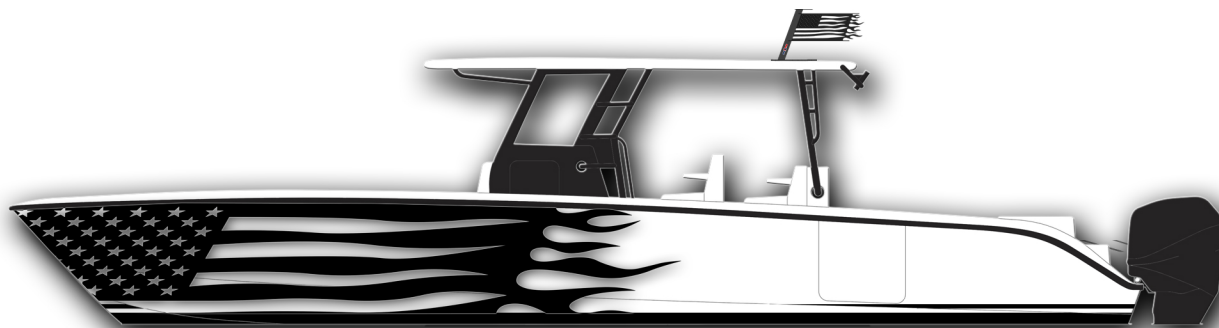

THE EXTREME FLAG FOR EXTREME BOATS SS-16EX

TRULY THE ULTIMATE AND EXTREME FAST-FLAG. THIS ITS UNIQUE STENCIL FLAME DESIGN, THIS FLAG CAN BE PAINTED TO SUIT YOUR BOATS GRAPHICS/COLOR SCHEME. ALL ALUMINUM CONSTRUCTION OPTIONAL MOUNTING PLATES, THIS FLAG WILL SET YOU APART FROM THE CROWD. IF YOU ARE INTERESTED, CONTACT FAST-FLAG.

ROSWELL ADAPTER PLATE FOR SS-16 & TT-16

THE ROSWELL ADAPTER PLATE - AVAILABLE FOR SS-16 AND TT-16 FLAGS, ARE DESIGNED AS AN INTERMEDIATE ADAPTER PLATE WHICH MAY BE USED TO ATTACH THE FLAG TO ANY VESSELS PRE-EXISTING PIPEWORK. ROSWELL UNIVERSAL 360 CLAMP ALSO HAS A SMALL 1/2" HOLE LOCATED AT THE TOP OF THE CLAMP TO ALLOW FOR WIRES TO PASS THROUGH IF YOU DESIRE TO INSTALL AN ANCHOR LIGHT OR LED LIGHT STRIPS. CONTACT FAST-FLAG FOR FURTHER INFORMATION.

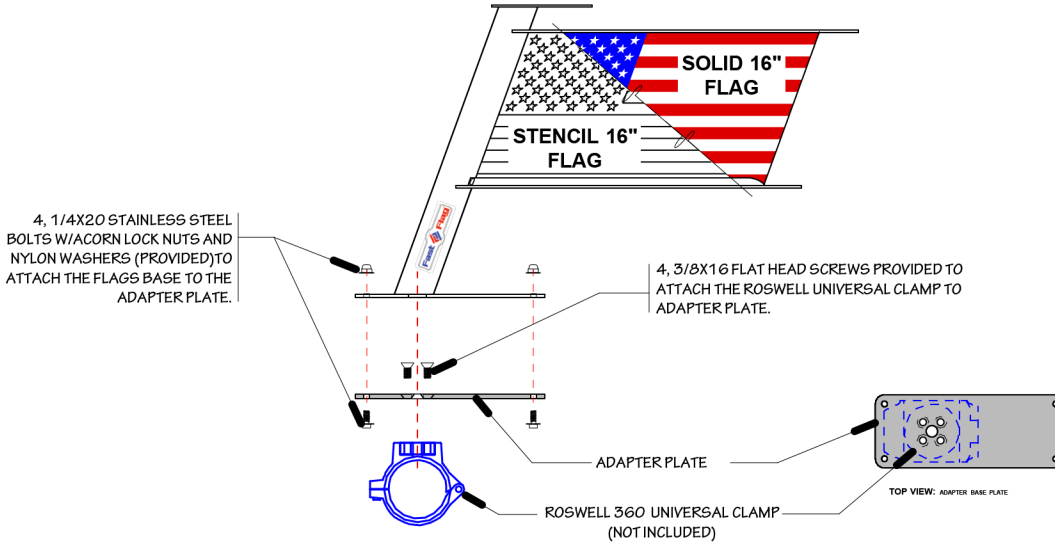

ROSWELL ADAPER PLATE FOR SS-16 STENCIL/SOLID

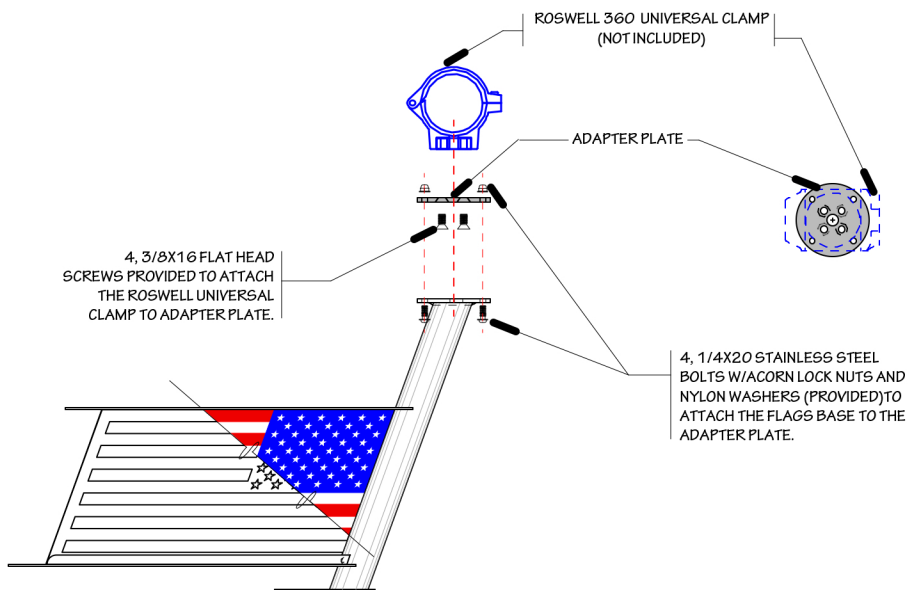

ROSWELL ADAPER PLATE FOR TT-16 STENCIL/SOLID

SS-10 & SS-6

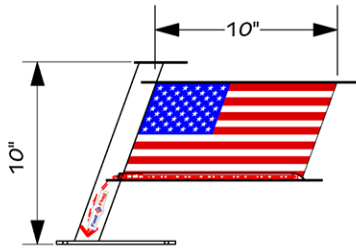

SS-10 SOLID R/W/B

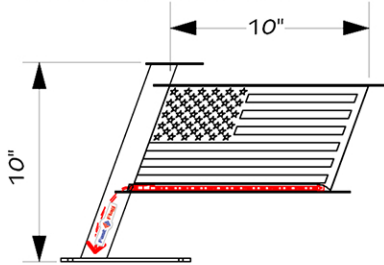

SS-10 STENCIL

SS-10 SOLID & STENCIL

THE COMPACT SIZE AND SIMPLE DESIGN OF THESE FLAGS MAKES FOR THE ULTIMATE ACCESSORY FLAG FOR ANYTHING THAT MOVES YOU SUCH AS A GOLF CART OR TENDER. THE SS-10 & SS-6 FLAGS ARE AVAILABLE ONLY WITH A FIXED BASE AND IN STENCIL (WHITE OR BLACK POWDER COAT) OR SOLID RED, WHITE AND BLUE VINYL APPLIQUE ONLY. LED LIGHT STRIPS IN COOL WHITE MAY BE ADDED TO ILLUMINATE YOUR FLAG AT NIGHT. (AVAILABLE ONLY FOR THE SS-10)

NOTE: ANCHOR LIGHT /MAST LIGHT CANNOT BE ATTACHED OR MOUNTED TO THESE FLAGS.

SS-6 SOLID & STENCIL

THERE'S NOTHING LIKE IT: THE SS-6 FLAG. BUILT TO THE EXACT SAME SPECIFICATIONS AS OUR FLAGSHIP SS-30 FLAG, IS AN ACCESSORY FLAG AND MAY BE MOUNTED ONTO ANYTHING THAT MOVES YOU ON LAND OR WATER.

NOTE: THIS FLAG IS ONLY AVAILABLE WITH A FIXED BASE. DO TO THE COMPACT SIZE AND SCALE OF THIS FLAG, ANCHOR LIGHT OR LED LIGHT STRIP OPTIONS ARE NOT AVAILABLE.

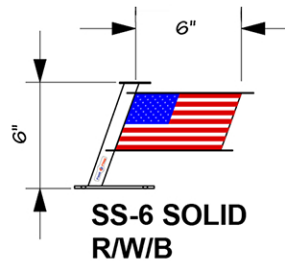

SS-6 SOLID R/W/B

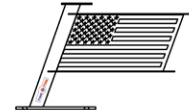

SS-6 STENCIL

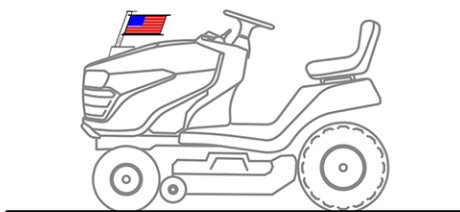
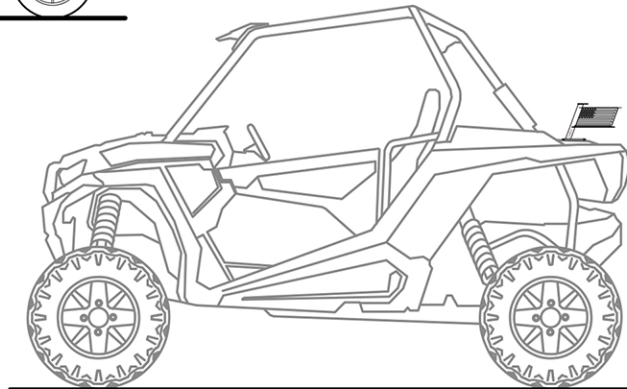
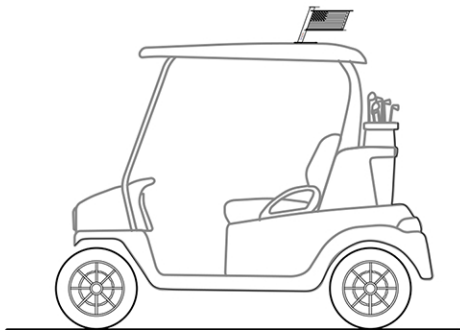
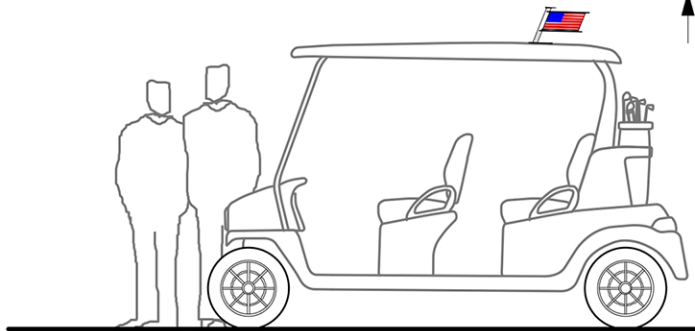

MB-10

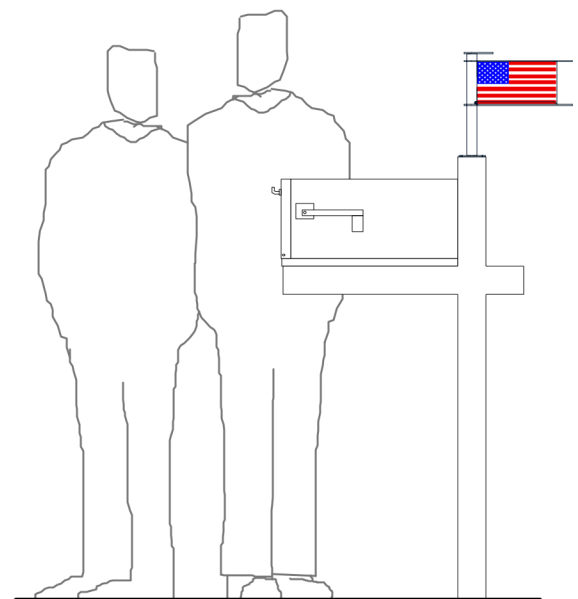
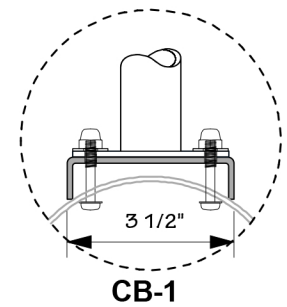
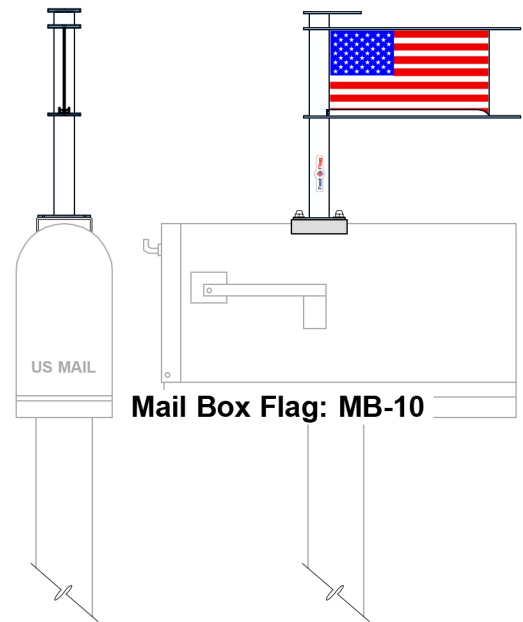
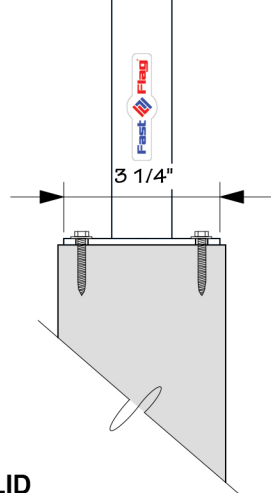
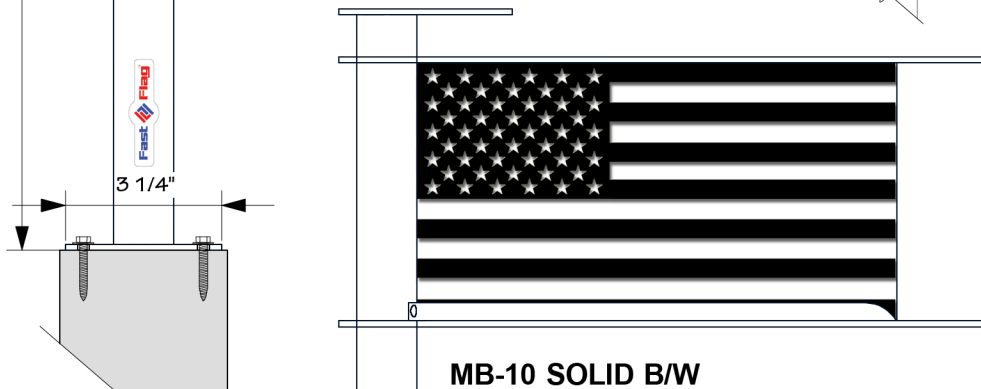
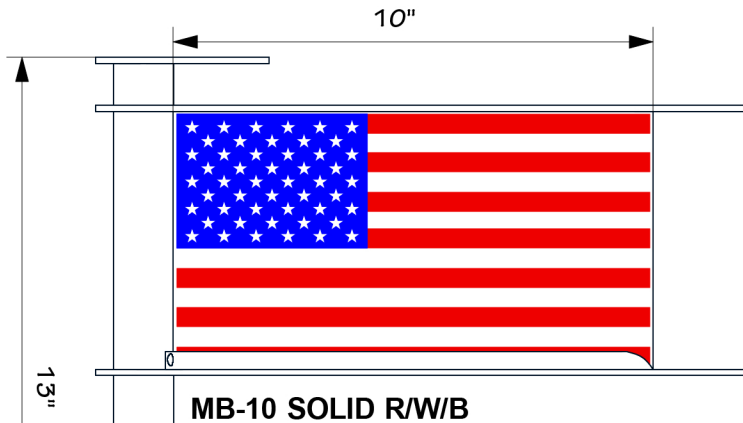
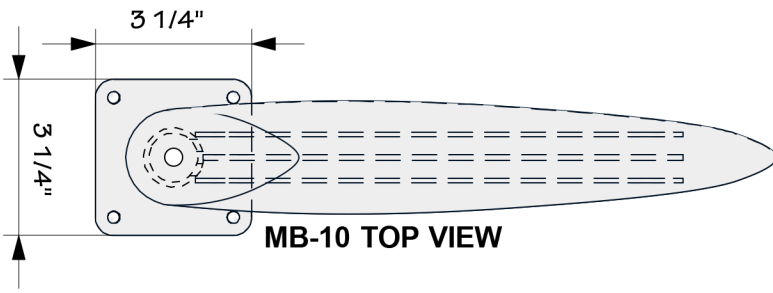

MB-10 SOLID

With its 90-degree vertical mast, the MB-10 is a compact flag similar to the DF-20 and DF-30. What sets this flag apart from the others is its small square mounting plate - perfect for attaching on top of any 4x4 post or, with the optional adapter base plate: CB-1, this flag can be mounted to any typical roadside mailbox. Like all Fast-Flags, the MB-10 is produced to the same standards you would expect - all aluminum construction and powder coated to last.

DF-30 & DF-20

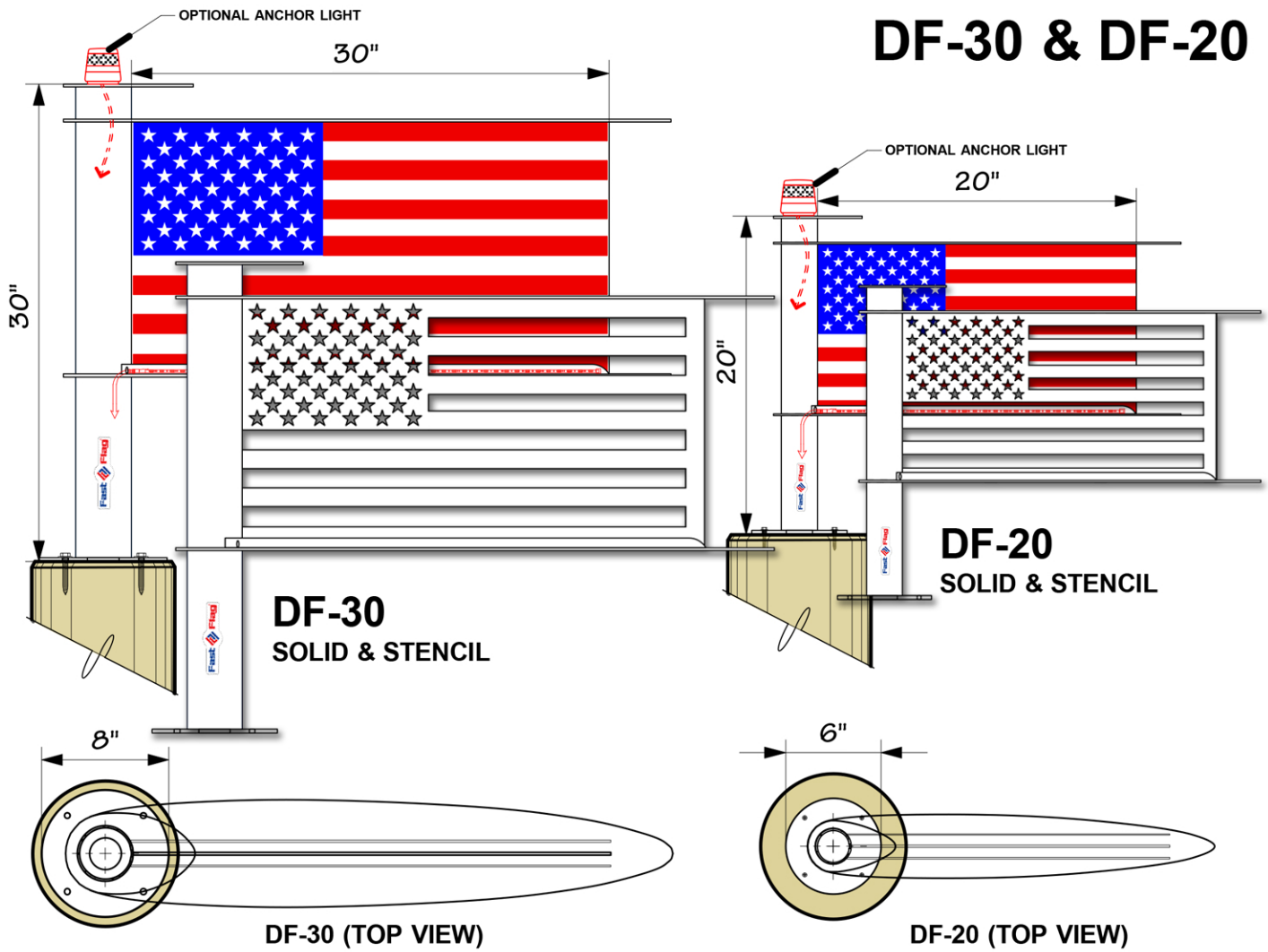

DF-20 & DF-30 SOLID & STENCIL

Built to the exact same standards that you'd expect from Fast-Flag: Solid, strong, yet lightweight all aluminum construction with laser cut components that are welded to perfection and powder coated to withstand the harsh marine climate. The DF-20 and DF-30 flags have a straight 90-degree mast - designed to be mounted on any solid stationary surface such as a dock, deck or piling.

Available in two sizes and may be illuminated with Plashlights IP-68 rated LED light strips. These flags will complement any dock, marina or outdoor entertainment area.



The Ultimate Dock Flag

YC-30

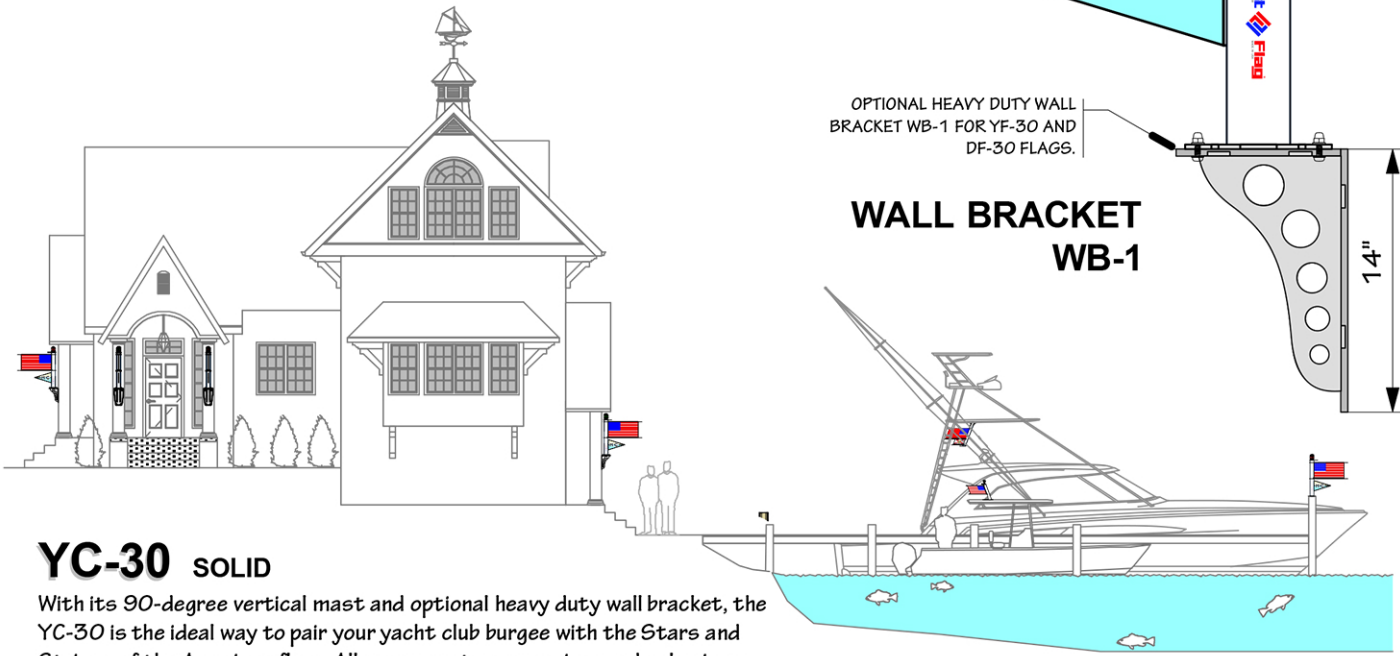
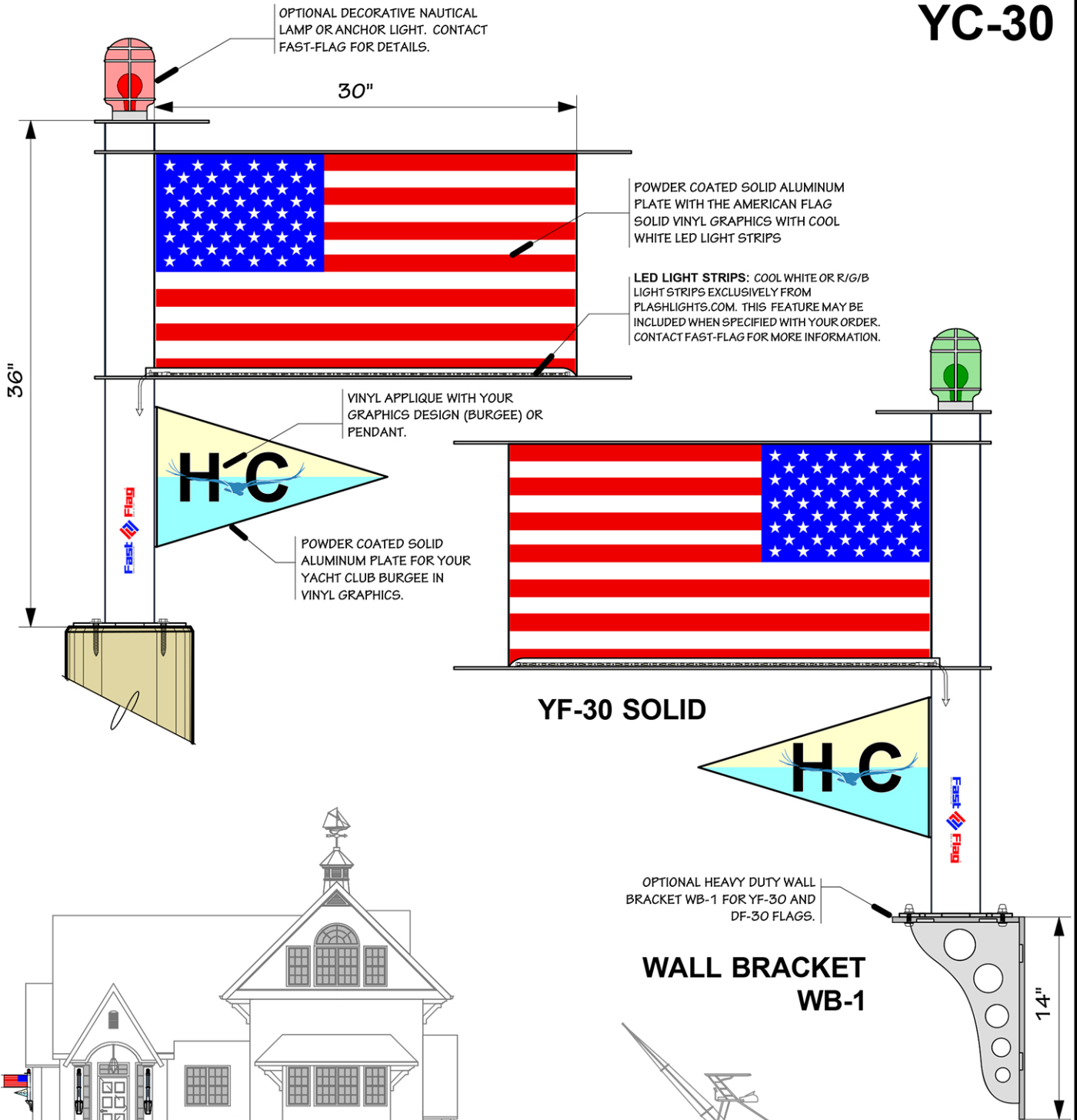

YC-30 SOLID

With its 90-degree vertical mast and optional heavy duty wall bracket, the YC-30 is the ideal way to pair your yacht club burgee with the Stars and Stripes of the American flag. All components are marine grade aluminum, laser cut with precision, welded to perfection and powder coated throughout to last a lifetime. Our graphics debatement can take your burgee design and convert it into a vinyl wrap design to last years and years. The YC-30 truly is the ultimate flag for your club, marina or dock.

RB-16

RB-16

The RB-16 is an optional base plate that is designed to go between your boat's hardtop/deck and any SS-16 Fast-Flag. When installed, this optional feature will enable the easy removal of the flag by way of 4 solid aluminum hand knobs. An access hole is provided, aligning with the flags mast to serve as a wire chase for LED light strip wires and or for anchor lamp wires.

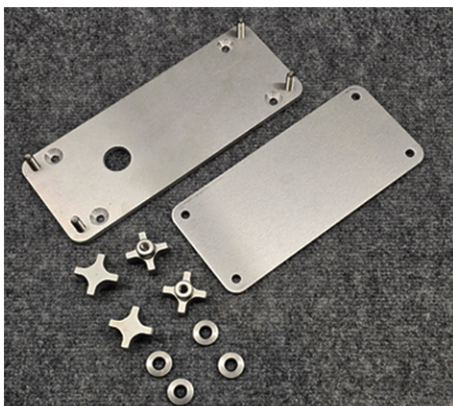
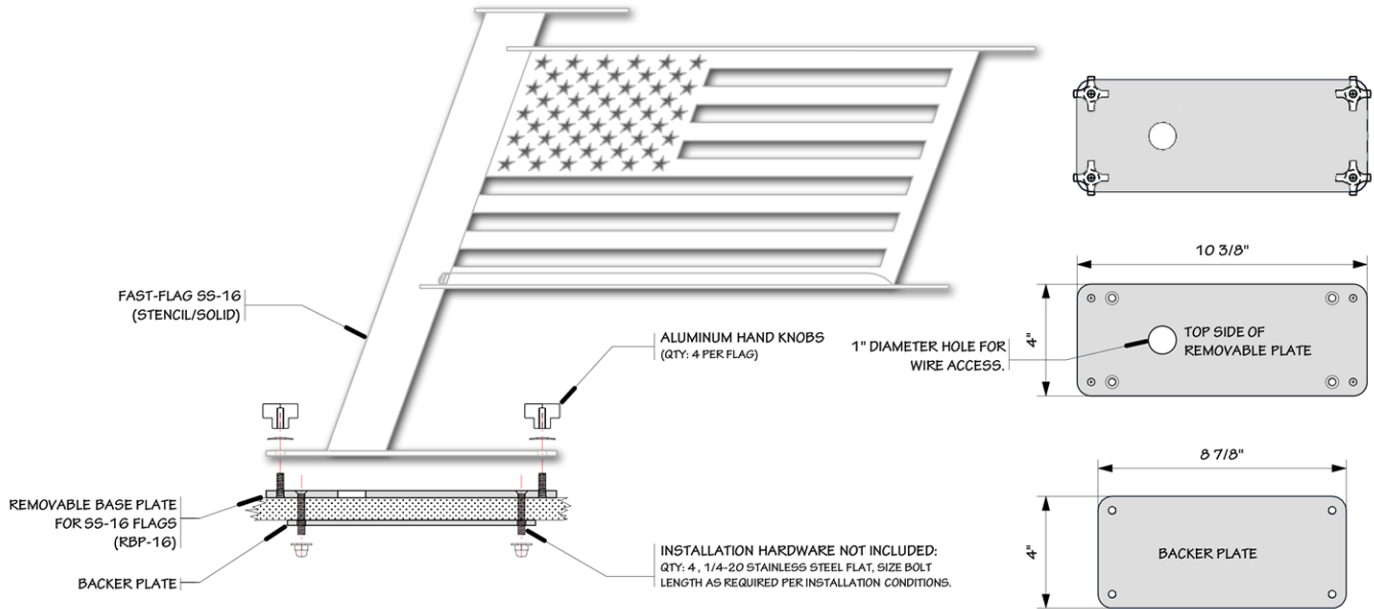

COLOR DESIGN OPTIONS FOR SS-30, SS-20 & SS-16

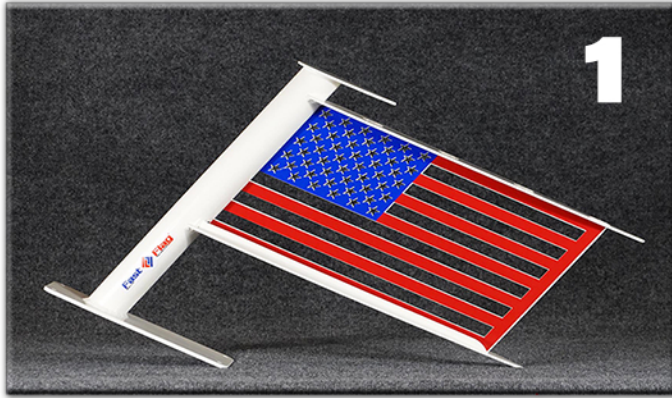

1

STENCIL RED & BLUE VINYL STENCIL
ON WHITE POWDER COAT

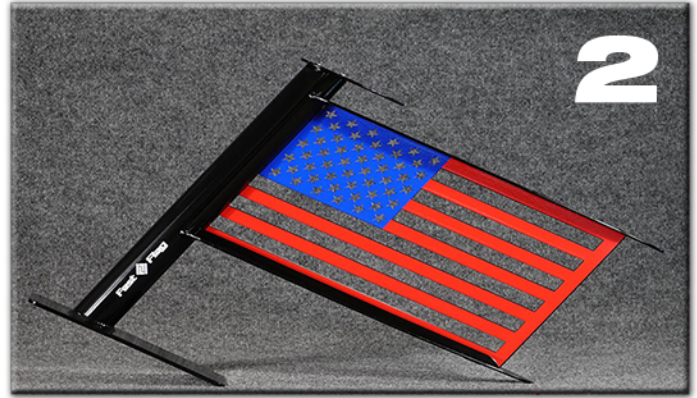

2

STENCIL RED & BLUE VINYL STENCIL
ON BLACK POWDER COAT

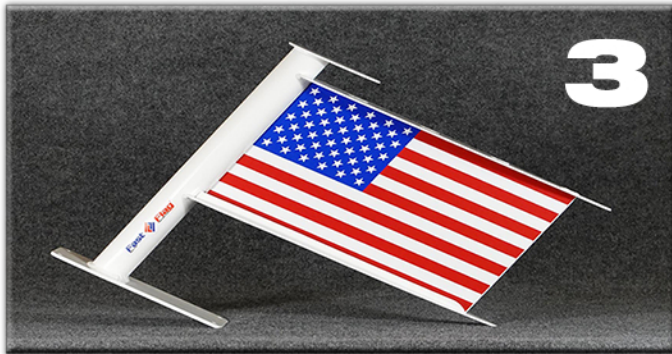

3

SOLID R/W/B SOLID VINYL
ON WHITE POWDER COAT



4

SOLID R/W/B SOLID VINYL
ON BLACK POWDER COAT

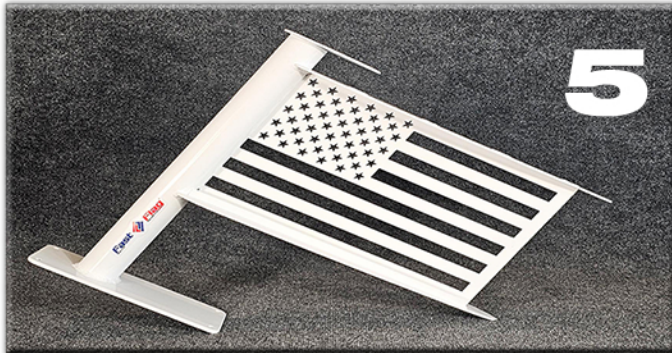

5

STENCIL (WHITE) POWDER COAT

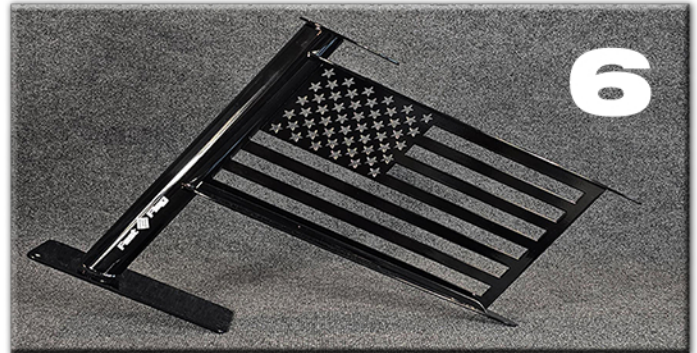

6

STENCIL (BLACK) POWDER COAT

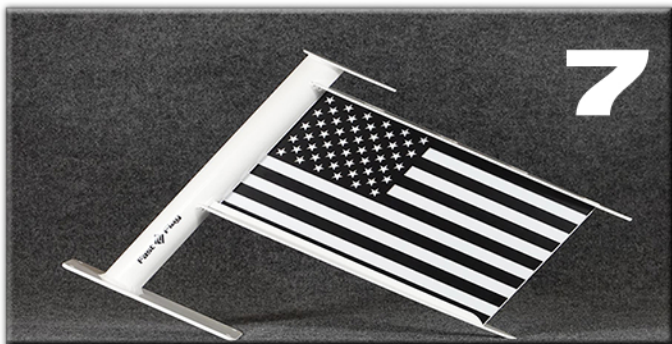

7

SOLID BLACK & WHITE SOLID VINYL
ON WHITE POWDER COAT



8

SOLID BLACK & WHITE SOLID VINYL
ON BLACK POWDER COAT

There are many factors and choices to process when considering a Fast-Flag. Given all the variables, options and features, the process may be overwhelming. Our design team and graphics experts are here to help you sort out all the issues and find the right fit and combination for you.

Our mission is simple - to produce a solid American flag proudly made in America. A flag that's like none other.
A flag you'd be proud to display - without exception.

Fast-Flag, the Ultimate Flag for Whatever Moves You.

Fast-Flag LLC

3425 Radio Rd., Suite 213
Naples, FL 34104

Tel: 239-529-6662

Fax: 239-529-5274

Email: info@fast-flag.com

Website: www.yourlastflag.com

Face Book: Fast Flag

Instagram: Fast_Flag

